

OUTDOOR UNIT SERVICE MANUAL

No. OBH502



Wireless type
Models

MUZ-D30NA
MUZ-D30NA-U1
MUZ-D36NA
MUZ-D36NA-U1
MUY-D30NA
MUY-D36NA

Indoor unit service manual
MSZ-D•NA Series (OBH501)
MSY-D•NA Series (OBH501)

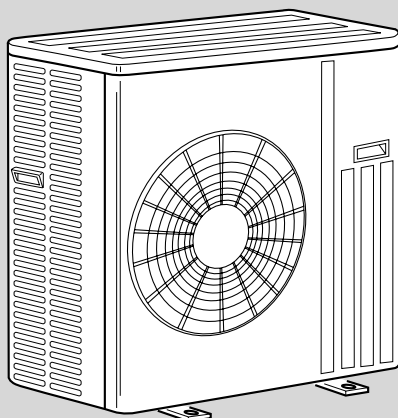

CONTENTS

1. TECHNICAL CHANGES	3
2. PART NAMES AND FUNCTIONS	3
3. SPECIFICATION	4
4. OUTLINES AND DIMENSIONS	6
5. WIRING DIAGRAM	7
6. REFRIGERANT SYSTEM DIAGRAM	9
7. DATA	11
8. ACTUATOR CONTROL	18
9. SERVICE FUNCTIONS	19
10. TROUBLESHOOTING	20
11. DISASSEMBLY INSTRUCTIONS	39

PARTS CATALOG (OBB502)

NOTE:
 RoHS compliant products have <G> mark on the spec name plate.

Mr. SLIM™

1

TECHNICAL CHANGES

MUZ-D30NA
MUZ-D30NA - U1
MUZ-D36NA
MUZ-D36NA - U1
MUY-D30NA
MUY-D36NA

1. New model

2

PART NAMES AND FUNCTIONS

MUZ-D30NA MUZ-D36NA
MUY-D30NA MUY-D36NA

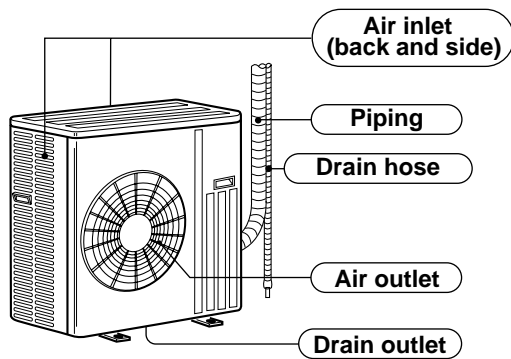

3

SPECIFICATION

Item		Model	MSZ-D30NA	MSY-D30NA	MSZ-D36NA	MSY-D36NA
Capacity Rated(Minimum~Maximum)	Cooling *1	Btu/h	30,700 (9,800 ~ 30,700)	30,700 (9,800 ~ 30,700)	32,000/33,200 (9,800 ~ 32,000) / (9,800 ~ 33,200)	33,200/34,600 (9,800 ~ 33,200) / (9,800 ~ 34,600)
	Heating 47 *1	Btu/h	32,600 (8,700 ~ 34,000)	—	35,200 (8,700 ~ 36,000)	—
Capacity Rated	Heating 17 *2	Btu/h	20,800	—	22,800	—
Power consumption Rated(Minimum~Maximum) (TOTAL)	Cooling *1	W	3,850 (620 ~ 3,850)	3,380 (620 ~ 3,380)	4,140/4,360 (620 ~ 4,140) / (620 ~ 4,360)	4,210/4,240 (620 ~ 4,210) / (620 ~ 4,240)
	Heating 47 *1	W	3,360 (520 ~ 3,600)	—	3,840 (520 ~ 4,100)	—
Power consumption Rated	Heating 17 *2	W	2,620	—	3,000	—
EER *1 [SEER] *3	Cooling		8.0 [14.5]	9.1 [16.0]	7.7/7.6 [14.5]	7.9/8.2 [15.1]
HSPF IV(V) *4	Heating		(8.2)	—	(8.2)	—
COP	Heating *1		2.84	—	2.69	—
Outdoor unit model			MUZ-D30NA	MUY-D30NA	MUZ-D36NA	MUY-D36NA
External finish			Munsell 3Y 7.8/1.1			
Power supply	V , phase , Hz		208/230 , 1 , 60			
Max. fuse size (time delay)	A		25			
Min. circuit ampacity	A		21			
Fan motor	F.L.A		0.93			
Compressor	Model		TNB220FMCHT			
	R.L.A		16			
	L.R.A		20			
Refrigerant control			Liner expansion valve			
Sound level *1	Cooling	dB(A)	55	55	56	56
	Heating	dB(A)	57	—	57	—
Defrost method			Reverse cycle	—	Reverse cycle	—
Dimensions	W	in.	33-1/16			
	D	in.	13			
	H	in.	33-7/16			
Weight	lb.	141	126	141	126	
Remote controller			Wireless type			
Control voltage (by built-in transformer)			12 - 24 VDC			
Refrigerant piping			Not supplied			
Refrigerant pipe size (Min. wall thickness)	Liquid	in.	3/8 (0.0315)			
	Gas	in.	5/8 (0.0394)			
Connection method	Indoor		Flared			
	Outdoor		Flared			
Between the indoor & outdoor units	Height difference	ft.	50			
	Piping length	ft.	100			
Refrigerant charge (R410A)			4 lb. 10 oz.	4 lb.	4 lb. 10 oz.	4 lb.
Refrigeration oil (Model)			NE022			

NOTE : Test conditions are based on ARI 210/240.

*1 : Rating conditions(Cooling) — Indoor : 80 °FDB, 67 °FWB, Outdoor : 95 °FDB, (75 °FWB)Rated frequency

(Heating) — Indoor : 70 °FDB, 60 °FWB, Outdoor : 47 °FDB, 43 °FWB Rated frequency

*2 : (Heating) — Indoor : 70 °FDB, 60 °FWB, Outdoor : 17 °FDB, 15 °FWBMaximum frequency

Test condition

※3,※4

ARI	Mode	Test	Indoor air condition		Outdoor air condition	
			Dry bulb (°F)	Wet bulb (°F)	Dry bulb (°F)	Wet bulb (°F)
	SEER (Cooling)	"A" Cooling Steady State at rated compressor Speed	80	67	95	(75)
		"B-2" Cooling Steady State at rated compressor Speed	80	67	82	(65)
		"B-1" Cooling Steady State at minimum compressor Speed	80	67	82	(65)
		Low ambient Cooling Steady State at minimum compressor Speed	80	67	67	(53.5)
		Intermediate Cooling Steady State at Intermediate compressor Speed ※5	80	67	87	(69)
	HSPF (Heating)	Standard Rating-Heating at rated compressor Speed	70	60	47	43
		Low temperature Heating at rated compressor Speed	70	60	17	15
		Max temperature Heating at minimum compressor Speed	70	60	62	56.5
		High temperature Heating at minimum compressor Speed	70	60	47	43
		Frost Accumulation at rated compressor Speed	70	60	35	33
		Frost Accumulation at Intermediate compressor Speed ※5	70	60	35	33

※5 : At Intermediate compressor Speed
 =("Cooling rated compressor speed" - "minimum compressor speed") / 3 + "minimum compressor speed".

OPERATING RANGE

(1) POWER SUPPLY

	Rated voltage	Guaranteed Voltage
Outdoor unit	208/230 V 1 phase 60 Hz	Min.187 V 208 V 230 V Max.253 V ----- ----- ----- ----- -----

(2) OPERATION

Mode	Condition	Intake air temperature (°F)			
		Indoor		Outdoor	
		DB	WB	DB	WB
Cooling	Standard temperature	80	67	95	—
	Maximum temperature	90	73	115	—
	Minimum temperature	67	57	14	—
	Maximum humidity	78 %		—	
Heating	Standard temperature	70	60	47	43
	Maximum temperature	80	67	75	65
	Minimum temperature	70	60	14	13

4

OUTLINES AND DIMENSIONS

MUZ-D30NA
 MUZ-D36NA
 MUY-D30NA
 MUY-D36NA

Unit: inch

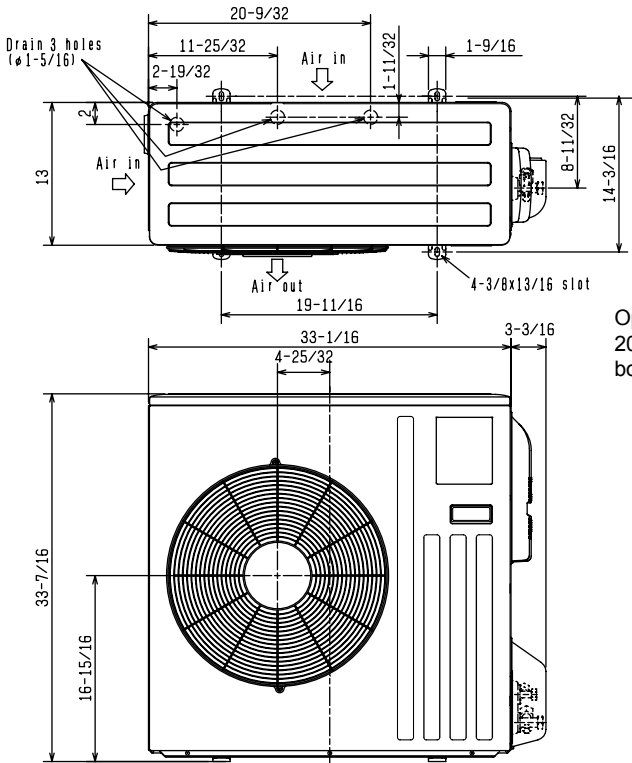

REQUIRED SPACE

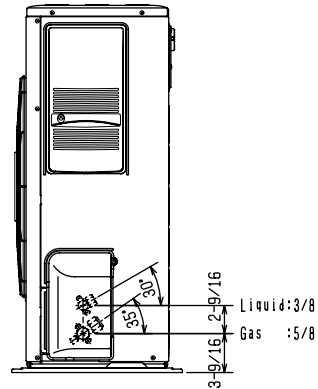
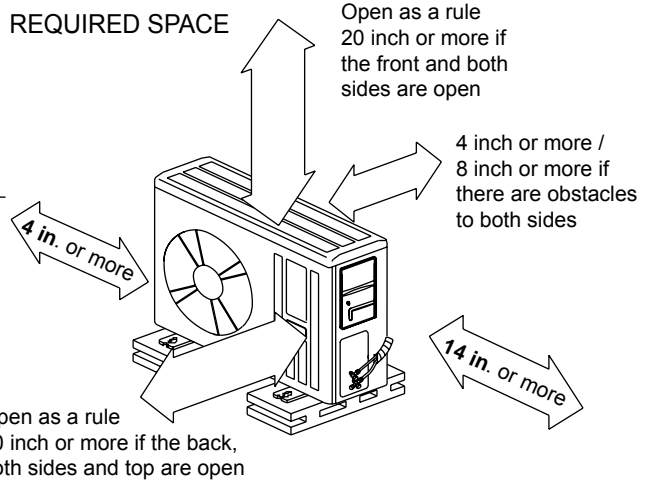

5

WIRING DIAGRAM

MUZ-D30NA MUZ-D36NA

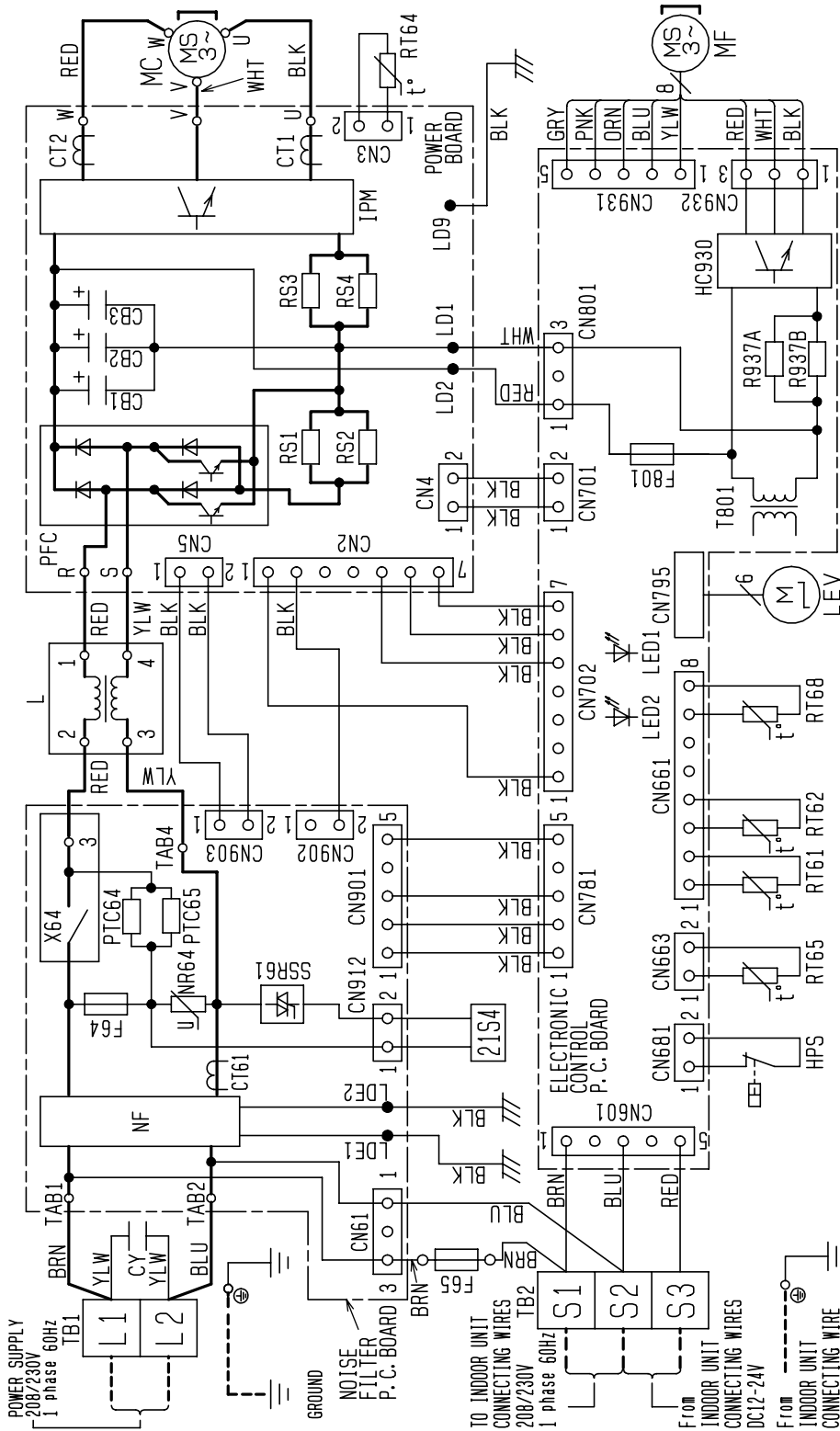

SYMBOL	NAME	SYMBOL	NAME	SYMBOL	NAME
CB1~3	SMOOTHING CAPACITOR	L	REACTOR	RT64	FIN TEMP. THERMISTOR
CT1,2	CURRENT TRANSFORMER	LEV	EXPANSION VALVE	RT65	AMBIENT TEMP. THERMISTOR
CT61	CURRENT TRANSFORMER	MC	COMPRESSOR	RT68	OUTDOOR HEAT EXCHANGER TEMP. THERMISTOR
CY	CAPACITOR	MF	FAN MOTOR	PTC64,65	RESISTOR
F64	FUSE (T2AL250V)	NF	NOISE FILTER	R937A,B	RESISTOR
F65	FUSE (T6.3AL250V)	NR64	VARIATOR	SSR61	SOLENOID COIL RELAY
F801	FUSE (T3.15AL250V)	PFC	POWER FACTOR CONTROLLER	TB1,2	TERMINAL BLOCK
HC930	INTELLIGENT POWER MODULE	RS1~4	RESISTOR	T801	SWITCHING TRANSFORMER
HPS	HIGH PRESSURE SWITCH	RT61	DEFROST THERMISTOR	X64	RELAY
IPM	INTELLIGENT POWER MODULE	RT62	DISCHARGE TEMP. THERMISTOR	Z1S4	REVERSING VALVE SOLENOID COIL

NOTES 1. About the indoor side electric wiring refer to the indoor unit electric wiring diagram for servicing.
 2. Use copper conductors only (for field wiring).
 3. Symbols below indicate.
 □: Terminal block

MUY-D30NA MUY-D36NA

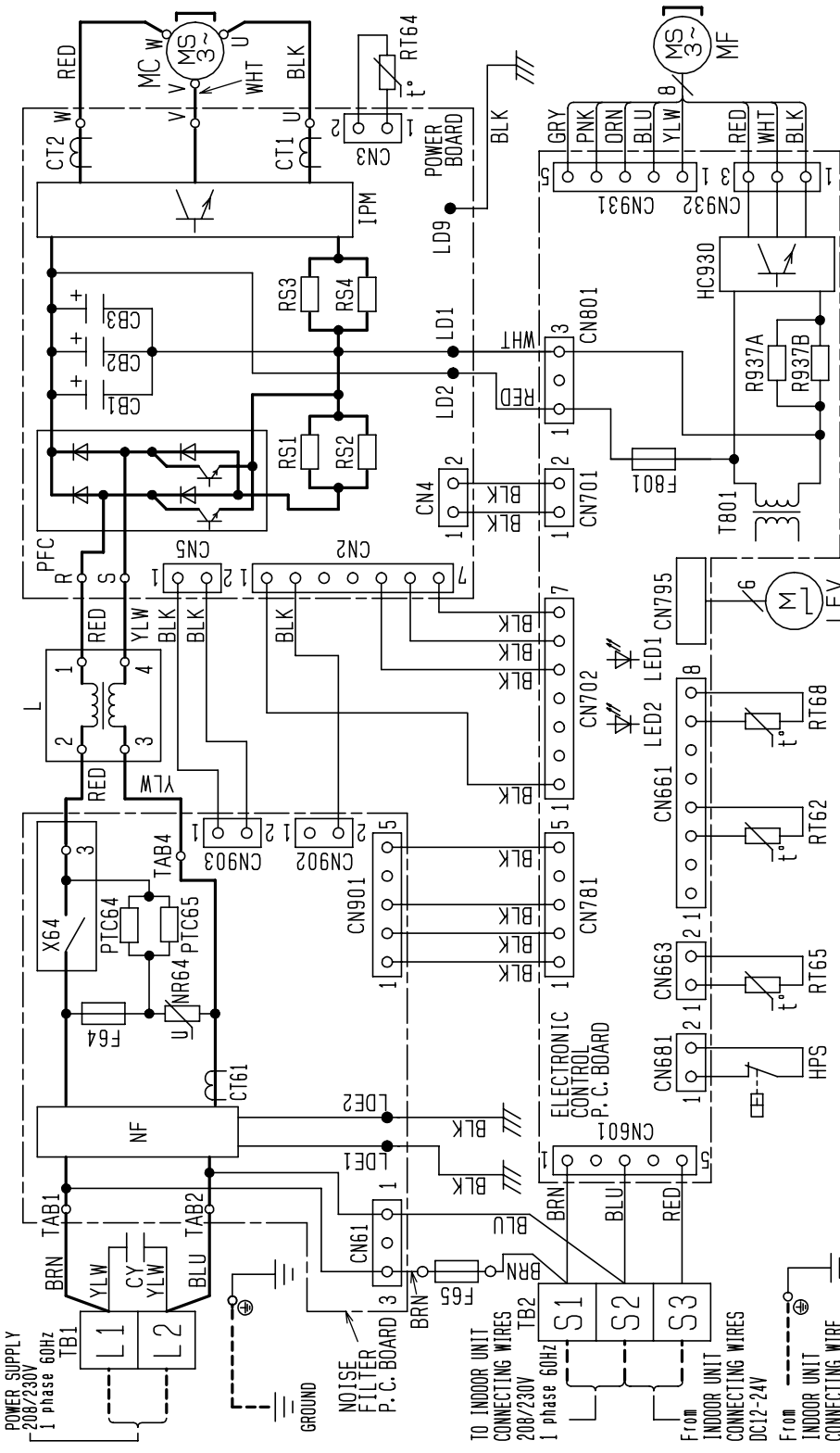

SYMBOL	NAME	SYMBOL	NAME	SYMBOL	NAME
CB1~3	SMOOTHING CAPACITOR	L	REACTOR	RT65	AMBIENT TEMP. THERMISTOR
CT1, 2	CURRENT TRANSFORMER	LEV	EXPANSION VALVE	RT68	OUTDOOR HEAT EXCHANGER TEMP. THERMISTOR
CT161	CURRENT TRANSFORMER	MC	COMPRESSOR	PTC64, 65	RESISTOR
CY	CAPACITOR	MF	FAN MOTOR	R937A, B	RESISTOR
F64	FUSE (T2AL250V)	NF	NOISE FILTER	TB1	TERMINAL BLOCK
F65	FUSE (T6.3AL250V)	NR64	VARISTOR	TB2	TERMINAL BLOCK
F801	FUSE (T3.15AL250V)	PEC	POWER FACTOR CONTROLLER	T801	SWITCHING TRANSFORMER
HC930	INTELLIGENT POWER MODULE	RS1~4	RESISTOR	X64	RELAY
HPS	HIGH PRESSURE SWITCH	RT62	DISCHARGE TEMP. THERMISTOR		
IPM	INTELLIGENT POWER MODULE	RT64	FIN TEMP. THERMISTOR		

NOTES
 1. About the indoor side electric wiring refer to the indoor unit electric wiring diagram for servicing.
 2. Use copper conductors only (for field wiring).
 3. Symbols below indicate.
 □□□□: Terminal block

6

REFRIGERANT SYSTEM DIAGRAM

MUZ-D30NA
MUZ-D36NA

Unit:inch

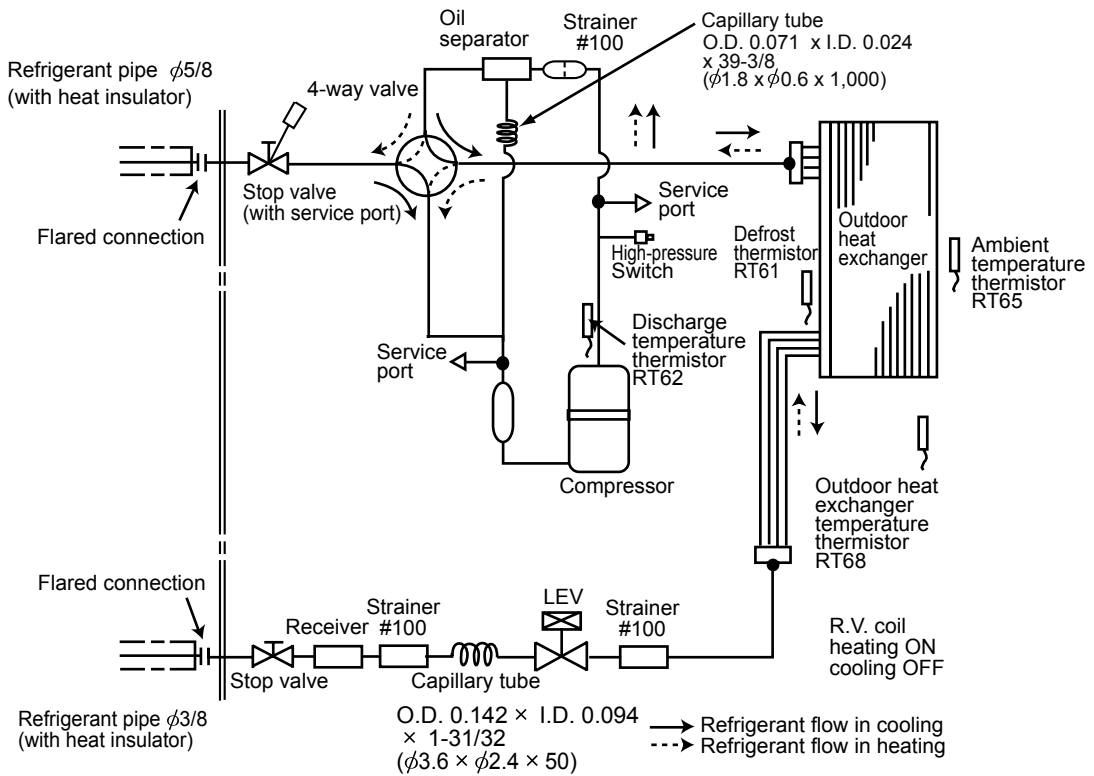

MUY-D30NA
MUY-D36NA

Unit:inch

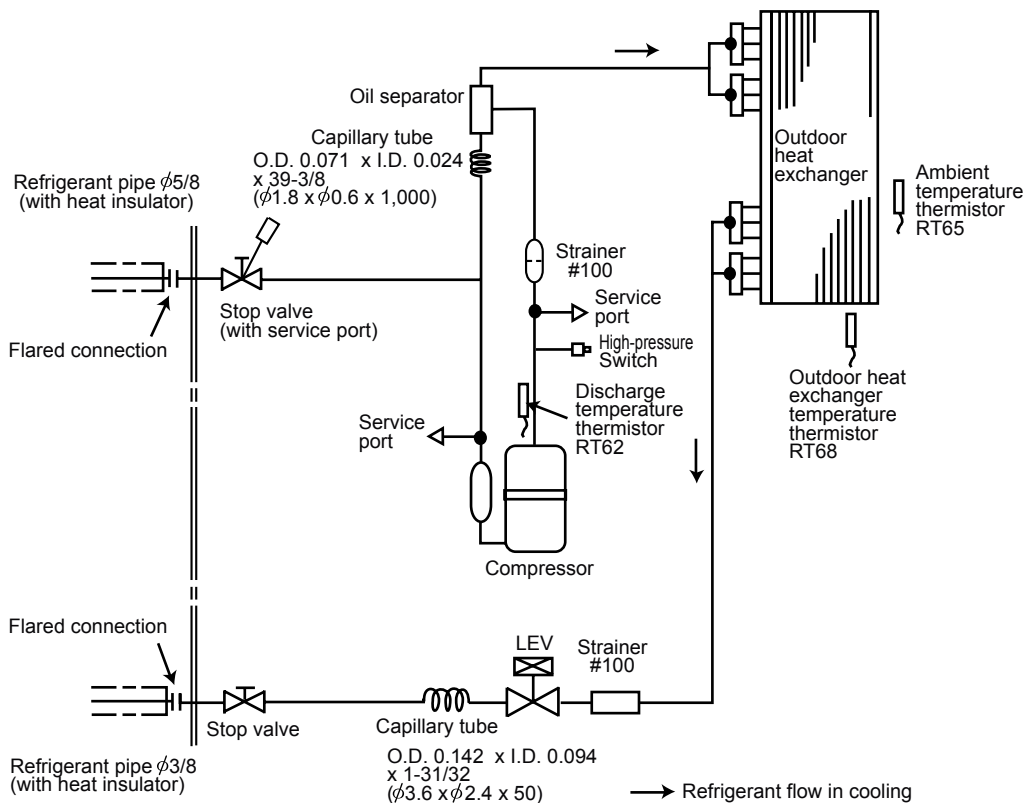

MAX. REFRIGERANT PIPING LENGTH and MAX. HEIGHT DIFFERENCE

Model	Refrigerant piping : ft.		Piping size O.D : in.	
	Max. Length A	Max. Height difference B	Gas	Liquid
MUZ-D30NA MUZ-D36NA MUY-D30NA MUY-D36NA	100	50	5/8	3/8

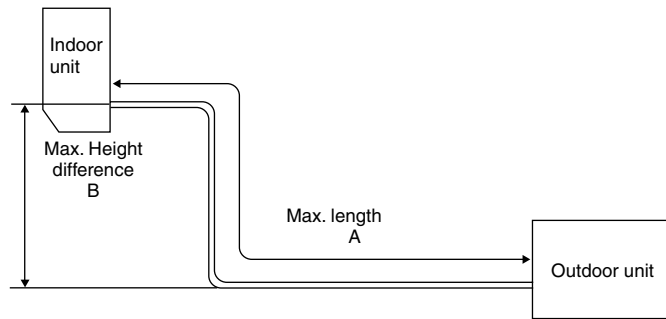

ADDITIONAL REFRIGERANT CHARGE (R410A:oz.)

Refrigerant piping exceeding 25 ft. requires additional refrigerant charge according to the calculation.

Model	Outdoor unit precharged	Refrigerant piping length (one way) : ft.								
		25	30	40	50	60	70	80	90	100
MUZ-D30NA MUZ-D36NA	4 lb. 10 oz.	0	2.96	8.88	14.80	20.72	26.64	32.56	38.48	44.40

Calculation : X oz. = 2.96/5 oz. / ft. x (Refrigerant piping length (ft.) - 25)

Model	Outdoor unit precharged	Refrigerant piping length (one way) : ft.								
		25	30	40	50	60	70	80	90	100
MUY-D30NA MUY-D36NA	4 lb.	0	1.08	3.24	5.40	7.56	9.72	11.88	14.04	16.20

Calculation : X oz. = 1.08/5 oz. / ft. x (Refrigerant piping length (ft.) - 25)

NOTE : Refrigerant piping exceeding 25 ft. requires additional refrigerant charge according to the calculation.

MUZ-D30NA MUZ-D36NA MUY-D30NA MUY-D36NA

7-1. PERFORMANCE DATA

1) COOLING CAPACITY

Model	Indoor air	Outdoor intake air DB temperature (°F)														
	IWB	75			85			95			105			115		
	(°F)	TC	SHC	TPC	TC	SHC	TPC	TC	SHC	TPC	TC	SHC	TPC	TC	SHC	TPC
MUZ-D30NA	71	37.6	19.1	3.43	35.2	17.8	3.75	33.0	16.7	4.04	30.7	15.6	4.25	28.2	14.3	4.43
	67	35.6	22.8	3.23	33.2	21.2	3.56	30.7	19.6	3.85	28.6	18.3	4.08	26.2	16.8	4.27
	63	33.5	25.9	3.08	31.0	24.0	3.41	28.9	22.3	3.68	26.2	20.3	3.93	23.9	18.5	4.08
MUZ-D36NA	71	40.7	19.8	3.88	38.0	18.5	4.25	35.7	17.4	4.58	33.2	16.2	4.82	30.5	14.9	5.01
	67	38.5	23.9	3.66	35.9	22.2	4.03	33.2	20.6	4.36	30.9	19.1	4.62	28.4	17.6	4.84
	63	36.2	27.3	3.49	33.5	25.3	3.86	31.2	23.5	4.16	28.4	21.4	4.45	25.9	19.5	4.62
MUY-D30NA	71	37.6	19.1	3.01	35.2	17.8	3.30	33.0	16.7	3.55	30.7	15.6	3.73	28.2	14.3	3.89
	67	35.6	22.8	2.84	33.2	21.2	3.13	30.7	19.6	3.38	28.6	18.3	3.58	26.2	16.8	3.75
	63	33.5	25.9	2.70	31.0	24.0	2.99	28.9	22.3	3.23	26.2	20.3	3.45	23.9	18.5	3.58
MUY-D36NA (208 V)	71	40.7	19.8	3.75	38.0	18.5	4.10	35.7	17.4	4.42	33.2	16.2	4.65	30.5	14.9	4.84
	67	38.5	23.9	3.54	35.9	22.2	3.89	33.2	20.6	4.21	30.9	19.1	4.46	28.4	17.6	4.67
	63	36.2	27.3	3.37	33.5	25.3	3.73	31.2	23.5	4.02	28.4	21.4	4.29	25.9	19.5	4.46
MUY-D36NA (230 V)	71	42.4	20.6	3.77	39.6	19.3	4.13	37.2	18.1	4.45	34.6	16.8	4.69	31.8	15.5	4.88
	67	40.1	24.9	3.56	37.4	23.2	3.92	34.6	21.5	4.24	32.2	20.0	4.49	29.6	18.3	4.71
	63	37.7	28.4	3.39	34.9	26.3	3.75	32.5	24.5	4.05	29.6	22.3	4.32	27.0	20.3	4.49

- NOTE :** 1. IWB : Intake air wet-bulb temperature
 TC : Total Capacity ($\times 10^3$ Btu/h)
 SHC : Sensible Heat Capacity ($\times 10^3$ Btu/h)
 TPC : Total Power Consumption (kW)
 2. SHC is based on 80 °F of indoor Intake air DB temperature.

2) COOLING CAPACITY CORRECTIONS

	Refrigerant piping length (one way : ft.)			
	25 (std.)	40	65	100
MUZ-D30NA MUZ-D36NA MUY-D30NA MUY-D36NA	1.0	0.95	0.878	0.713

3) HEATING CAPACITY

Model	Indoor air	Outdoor intake air WB temperature (°F)											
	IDB	15		25		35		43		45		55	
	(°F)	TC	TPC	TC	TPC	TC	TPC	TC	TPC	TC	TPC	TC	TPC
MUZ-D30NA	75	18.9	2.50	23.6	2.94	28.2	3.28	31.8	3.44	32.8	3.49	37.2	3.63
	70	20.0	2.42	24.5	2.87	28.9	3.19	32.6	3.36	33.6	3.43	38.0	3.56
	65	20.5	2.32	25.6	2.77	29.8	3.11	33.6	3.28	34.6	3.33	38.8	3.49
MUZ-D36NA	75	20.4	2.86	25.5	3.36	30.4	3.74	34.3	3.94	35.4	3.99	40.1	4.15
	70	21.6	2.76	26.4	3.28	31.2	3.65	35.2	3.84	36.3	3.92	41.0	4.07
	65	22.2	2.65	27.6	3.17	32.2	3.55	36.3	3.74	37.3	3.80	41.9	3.99

- NOTE :** 1. IDB : Intake air dry-bulb temperature
 TC : Total Capacity ($\times 10^3$ Btu/h)
 TPC : Total Power Consumption (kW)
 2. Above data is for heating operation without any frost.

How to operate with fixed operational frequency of the compressor.

1. Press the EMERGENCY OPERATION switch on the front of the indoor unit, and select either EMERGENCY COOL mode or EMERGENCY HEAT mode before starting to operate the air conditioner.
2. The compressor starts with operational frequency.
3. The fan speed of the indoor unit is High.
4. This operation continues for 30 minutes.
5. In order to release this operation, press the EMERGENCY OPERATION switch twice or once, or press any button on the remote controller.

7-2. PERFORMANCE CURVE

Cooling

MUZ-D30NA

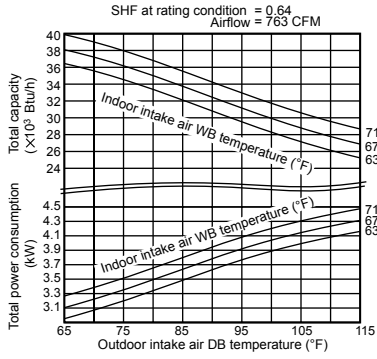

MUZ-D36NA

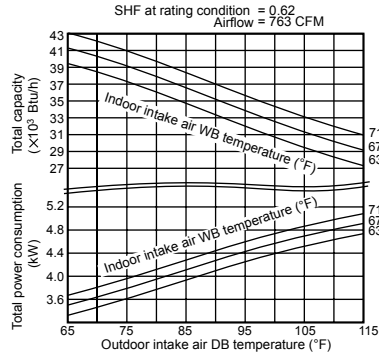

MUY-D30NA

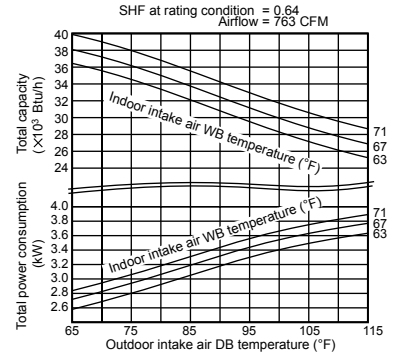

MUY-D36NA

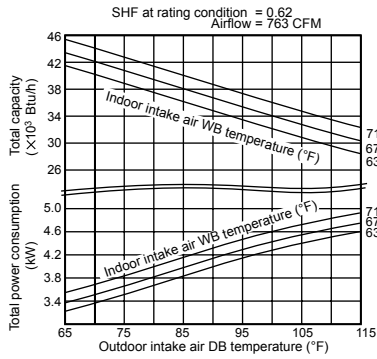

Heating

MUZ-D30NA

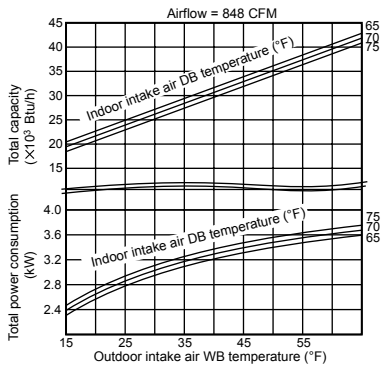

MUZ-D36NA

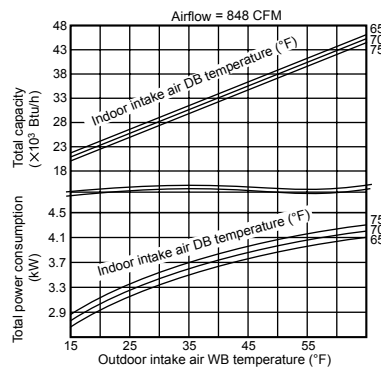

This value of frequency is not the same as the actual SHF in operating. Refer to 7-5 and 7-6 for the relationships between frequency and capacity.

7-3. CONDENSING PRESSURE

Cooling

Data is based on the condition of indoor humidity 50 %.

Air flow should be set to High speed.

MUZ-D30NA

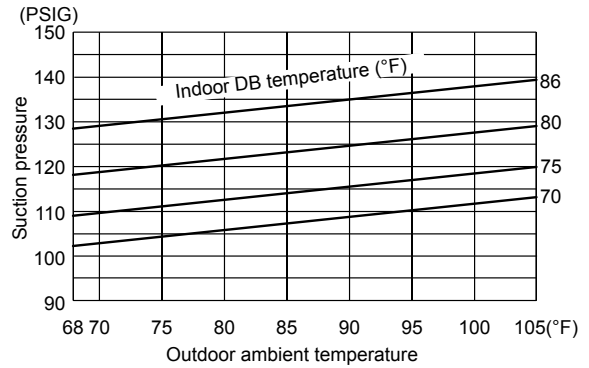
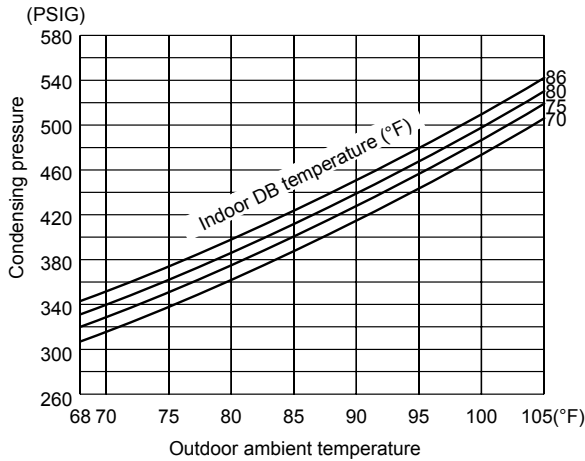

MUZ-D36NA

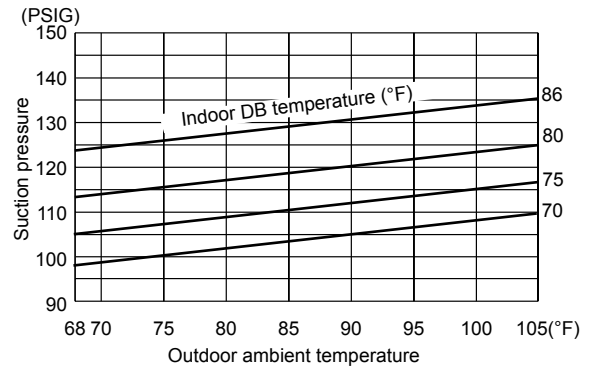
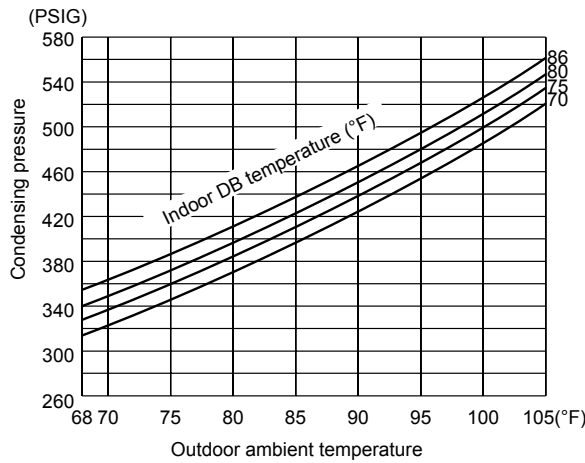

MUY-D30NA

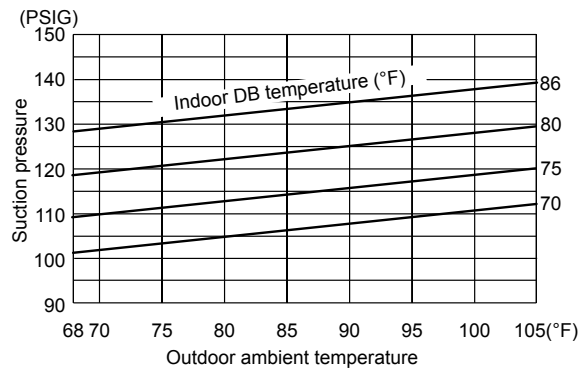
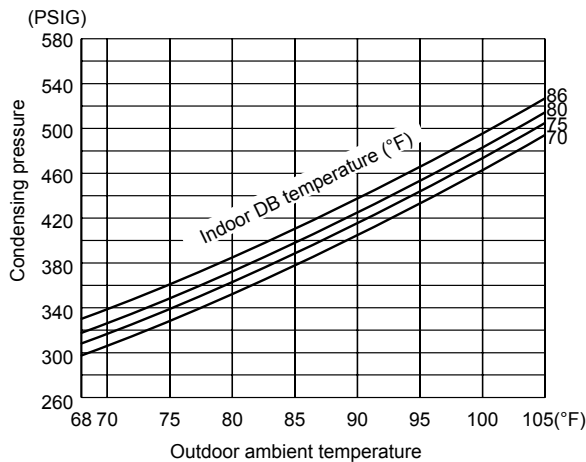

MUY-D36NA

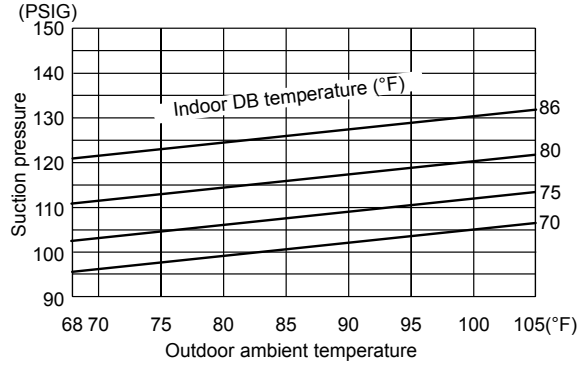
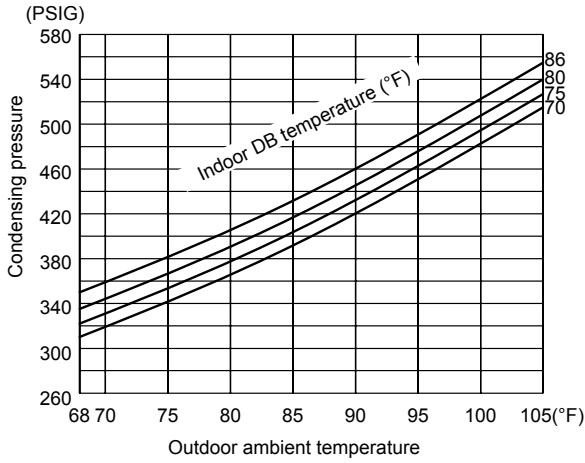

Heating

Data is based on the condition of outdoor humidity 75 %.
Air flow should be set to High speed.
Data is for heating operation without any frost.

MUZ-D30NA

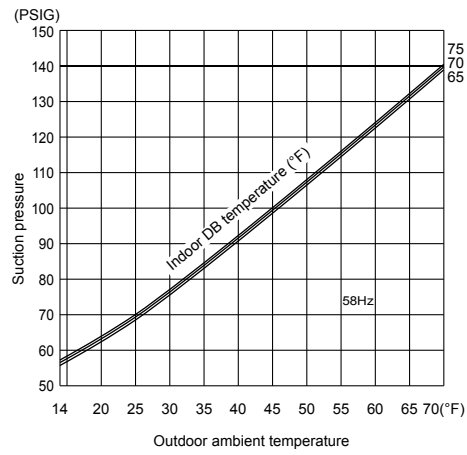
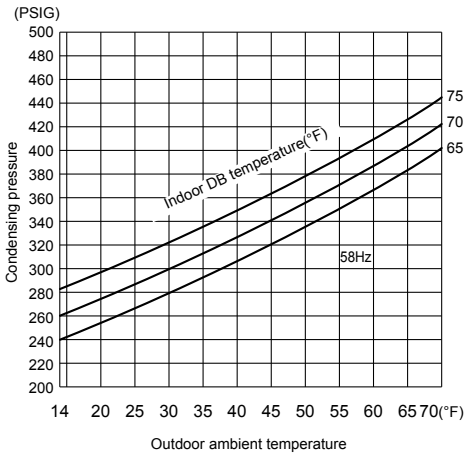

MUZ-D36NA

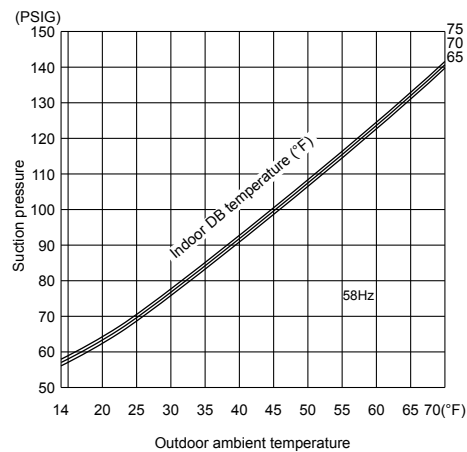
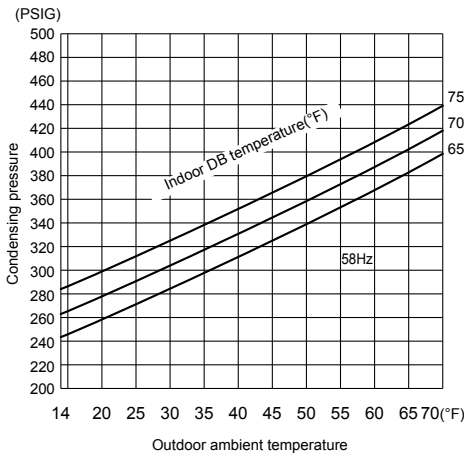

7-4. STANDARD OPERATION DATA

Model			MSZ-D30NA		MSZ-D36NA		MSY-D30NA	MSY-D36NA		
Item		Unit	Cooling	Heating	Cooling	Heating	Cooling	Cooling		
Total	Capacity	Btu / h	30,700	32,600	32,000/33,200	35,200	30,700	33,200/34,000		
	SHF	—	0.64	—	0.62	—	0.64	0.62		
	Input	kW	3.85	3.36	4.14/4.36	3.84	3.38	4.21/4.24		
	Rated frequency	Hz	84	84	91	91	79	92		
Indoor unit			MSZ-D30NA		MSZ-D36NA		MSY-D30NA	MSY-D36NA		
Power supply		V, phase, Hz	208/230 , 1 , 60							
Input		kW	0.058							
Fan motor current		A	0.45/0.42							
Outdoor unit			MUZ-D30NA		MUZ-D36NA		MUY-D30NA	MUY-D36NA		
Power supply		V, phase, Hz	208/230 , 1 , 60							
Input		kW	3.792	3.302	4.082/4.302	3.782	3.322	4.152/4.182		
Comp. current		A	17.25/15.56	14.95/13.46	18.65/17.86	17.25/15.56	15.05/13.56	18.95/17.26		
Fan motor current		A	0.80/0.72							
Refrigerant circuit	Condensing pressure		PSIG	468	404	480	420	453	475	
	Suction pressure		PSIG	126	96	122	94	125	119	
	Discharge temperature		°F	186.8	169.7	198.7	168.8	191.3	197.1	
	Condensing temperature		°F	126.5	114.3	128.5	117.0	123.8	127.4	
	Suction temperature		°F	45.5	29.8	48.0	29.1	54.7	48.6	
	Comp. shell bottom temperature		°F	175.6	156.4	187.0	155.7	177.4	182.7	
	Ref. pipe length		ft.	25						
	Refrigerant charge (R410A)		—	4 lb. 10 oz.				4 lb.		
Indoor unit	Intake air temperature		DB	°F	80	70	80	70	80	80
			WB	°F	67	60	67	60	67	67
	Discharge air temperature		DB	°F	53.9	112.2	53	114.9	53.7	51.7
			WB	°F	53	73.9	52.1	74.6	52.8	50.8
	Fan speed (High)		rpm	1,100						
Airflow (High)		CFM	741 (Wet)	795	738 (Wet)	794	718 (Wet)	710 (Wet)		
Outdoor unit	Intake air temperature		DB	°F	95	47	95	47	95	95
			WB	°F	—	43	—	43	—	—
	Fan speed		rpm	800						
Airflow		CFM	1,941							

7-5. CAPACITY AND INPUT CORRECTION BY INVERTER OUTPUT FREQUENCY

MUZ-D30NA

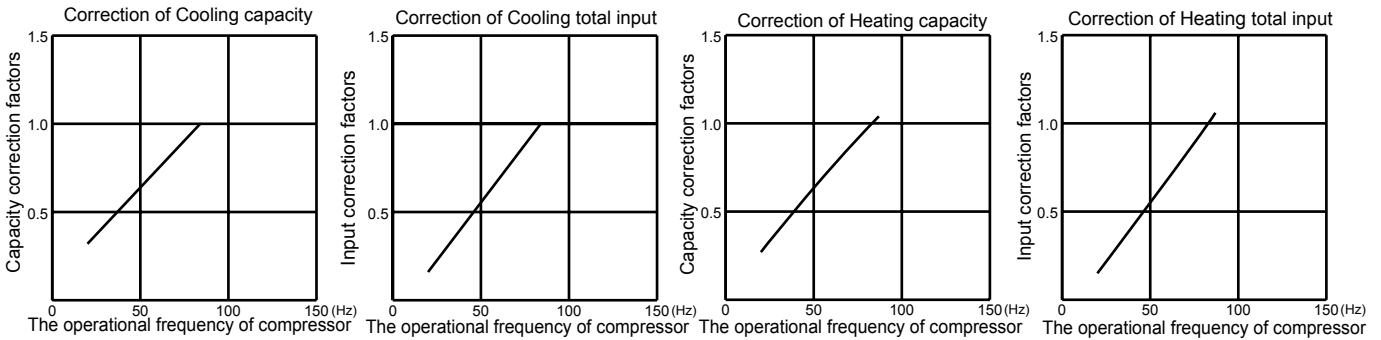

MUZ-D36NA

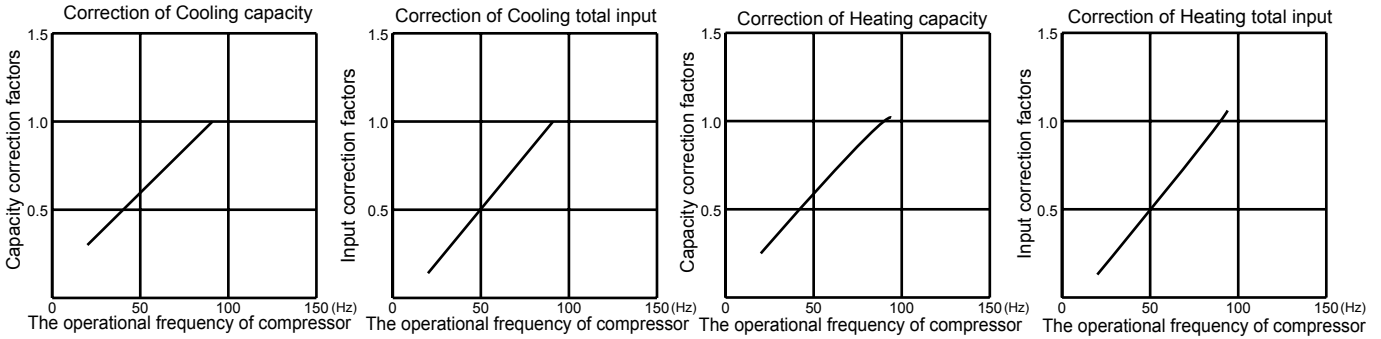

MUY-D30NA

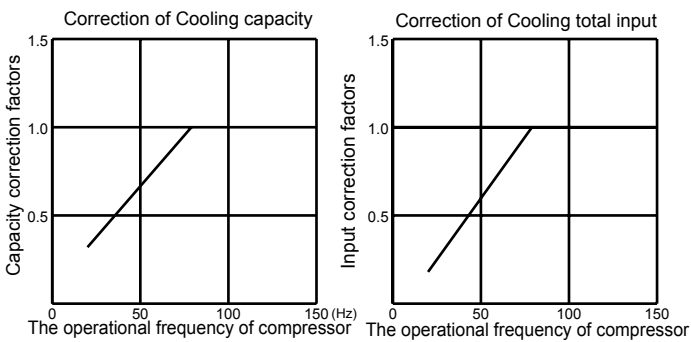

MUY-D36NA

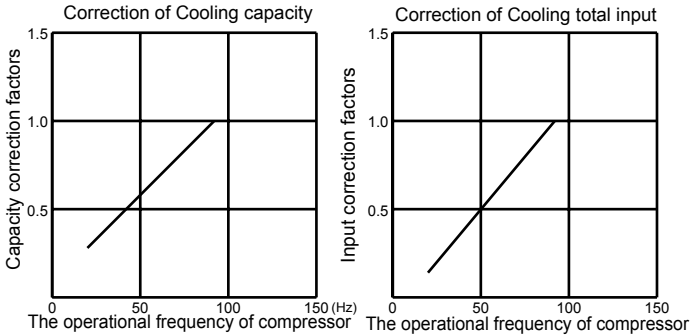



7-6. TEST RUN OPERATION (How to operate fixed-frequency operation)

1. Press EMERGENCY OPERATION switch to COOL or HEAT mode (COOL : Press once, HEAT : Press twice).
2. Test run operation starts and continues to operate for 30 minutes.
3. Compressor operates at rated frequency in COOL mode or 58 Hz in HEAT mode.
4. Indoor fan operates at High speed.
5. After 30 minutes, test run operation finishes and EMERGENCY OPERATION starts (Operation frequency of compressor varies).
6. To cancel test run operation (EMERGENCY OPERATION), press EMERGENCY OPERATION switch or any button on remote controller.

**MUZ-D30NA
MUZ-D36NA
MUY-D30NA
MUY-D36NA**

8-1. OUTDOOR FAN MOTOR CONTROL

The fan motor turns ON/OFF, interlocking with the compressor.

[ON] The fan motor turns ON 5 seconds before the compressor starts up.

[OFF] The fan motor turns OFF 15 seconds after the compressor has stopped running.

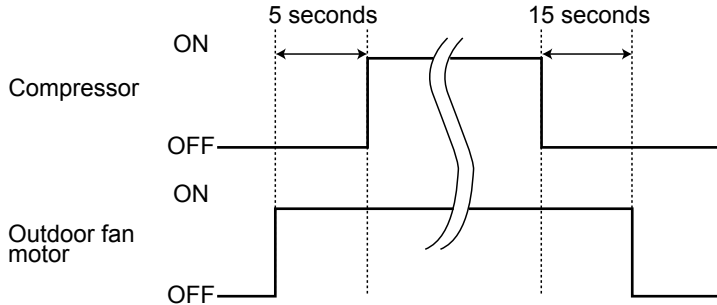

8-2. R.V. COIL CONTROL

<MUZ>

- Heating ON
- Cooling OFF
- Dry OFF

NOTE: The 4-way valve reverses for 5 seconds right before start-up of the compressor.

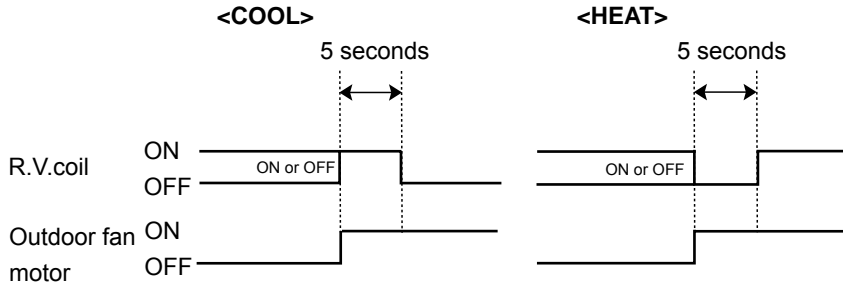

8-3. Relation between main sensor and actuator

Sensor	Purpose	Actuator				
		Compressor	LEV	Outdoor fan motor	R.V. coil	Indoor fan motor
Discharge temperature thermistor	Protection	○	○			
Indoor coil temperature thermistor	Cooling : Coil frost prevention	○				
	Heating : High pressure protection	○	○	○		
Defrost thermistor	Defrosting	○	○	○	○	○
Fin temperature thermistor	Protection	○		○		
Outdoor heat exchanger temperature	Protection	○	○	○		
Ambient temperature thermistor	Cooling : Low ambient temperature operation	○	○	○		

MUZ-D30NA MUZ-D36NA MUY-D30NA MUY-D36NA

9-1. PRE-HEAT CONTROL

If moisture gets into the refrigerant cycle, or when refrigerant is liquefied and collected in the compressor, it may interfere the start-up of the compressor. To improve start-up condition, the compressor is energized even while it is not operating.

This is to generate heat at the winding.

The compressor uses about 50 W when pre-heat control is turned ON.

Pre-heat control is ON at initial setting.

[How to activate pre-heat control]

1. Turn OFF the power supply for the air conditioner before making the setting.
2. Set the 2nd Dip Switch of SW1 on the outdoor electronic control P.C. board to ON to activate pre-heat control function.

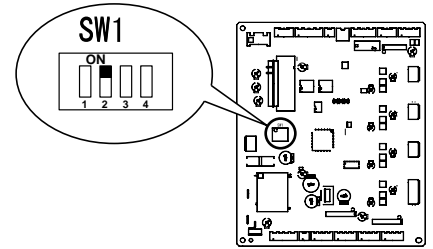

The compressor is energized even while it is not operating.

This is to generate heat at the winding to improve the compressor's start-up condition.

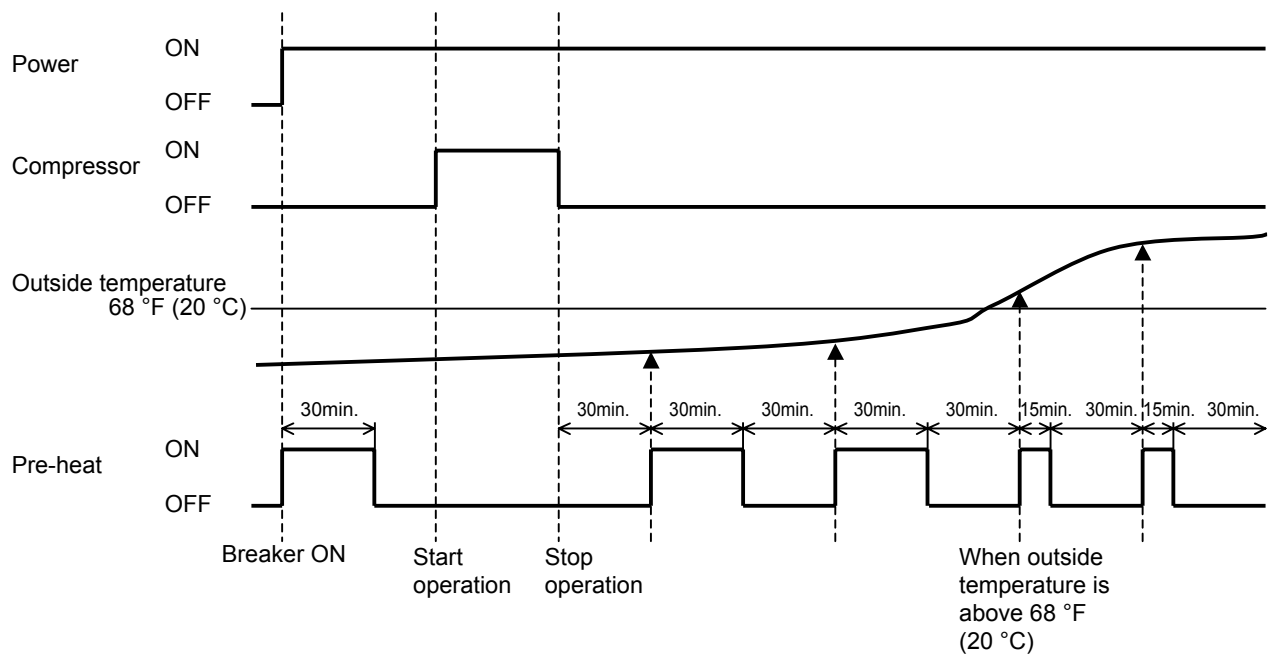

1. Pre-heat control is turned ON for 15 or 30 min.* after the breaker is turned ON.
 2. 30 min. after the unit is stopped, pre-heat control is turned ON for 15 or 30 min.* and turned OFF for 30 min. This is repeated as shown in the graph until the breaker is turned OFF.
- * When outside temperature is 68 °F (20 °C) or below, pre-heat control is ON for 30 min.
When outside temperature is 70 °F (21 °C) or above, pre-heat control is ON for 15 min.

NOTE: When the unit is started with the remote controller, pre-heat control is turned OFF.
Compressor uses 50 W when pre-heat control is turned ON.

9-2. CHANGE IN DEFROST SETTING

Changing defrost finish temperature

1. Turn OFF the power supply for the air conditioner before making the setting.
2. Set the 4th Dip Switch of SW1 on the outdoor electronic control P.C. board to ON to change the defrost finish temperature. (Refer to 10-6-1.)

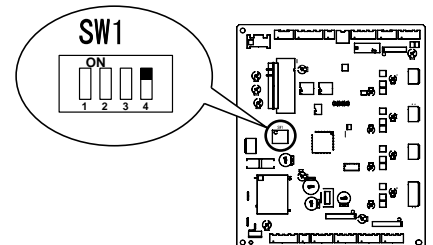

4th Dip Switch of SW1	Defrost finish temperature
OFF (Initial setting)	49.5 °F (9.7 °C)
ON	64.9 °F (18.3 °C)

MUZ-D30NA MUZ-D36NA MUY-D30NA MUY-D36NA**10-1. CAUTIONS ON TROUBLESHOOTING****1. Before troubleshooting, check the following**

- 1) Check the power supply voltage.
- 2) Check the indoor/outdoor connecting wire for miswiring.

2. Take care of the following during servicing

- 1) Before servicing the air conditioner, be sure to turn OFF the main unit first with the remote controller, then after confirming the horizontal vane is closed, turn off the breaker and / or disconnect the power plug.
- 2) Be sure to turn OFF the power supply before removing the front panel, the cabinet, the top panel, and the electronic control P.C. board.
- 3) When removing the electrical parts, be careful to the residual voltage of smoothing capacitor.
- 4) When removing the electronic control P.C. board, hold the edge of the board with care NOT to apply stress on the components.
- 5) When connecting or disconnecting the connectors, hold the housing of the connector. DO NOT pull the lead wires.

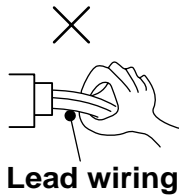
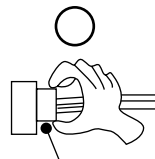
**Lead wiring****Housing point****3. Troubleshooting procedure**

- 1) First, check if the OPERATION INDICATOR lamp on the indoor unit is flashing on and off to indicate an abnormality. To make sure, check how many times the abnormality indication is flashing on and off before starting service work.
- 2) Before servicing check that the connector and terminal are connected properly.
- 3) When the electronic control P.C. board seems to be defective, check the copper foil pattern for disconnection and the components for bursting and discoloration.
- 4) Refer to 10-2. and 10-3.

10-2. FAILURE MODE RECALL FUNCTION

Outline of the function

This air conditioner can memorize the abnormal condition which has occurred once.

Even though LED indication listed on the troubleshooting check table (10-3.) disappears, the memorized failure details can be recalled.

This mode is very useful when the unit needs to be repaired for the abnormality which doesn't recur.

1. Flow chart of failure mode recall function for the indoor/outdoor unit

Operational procedure

This figures show about MSZ type.

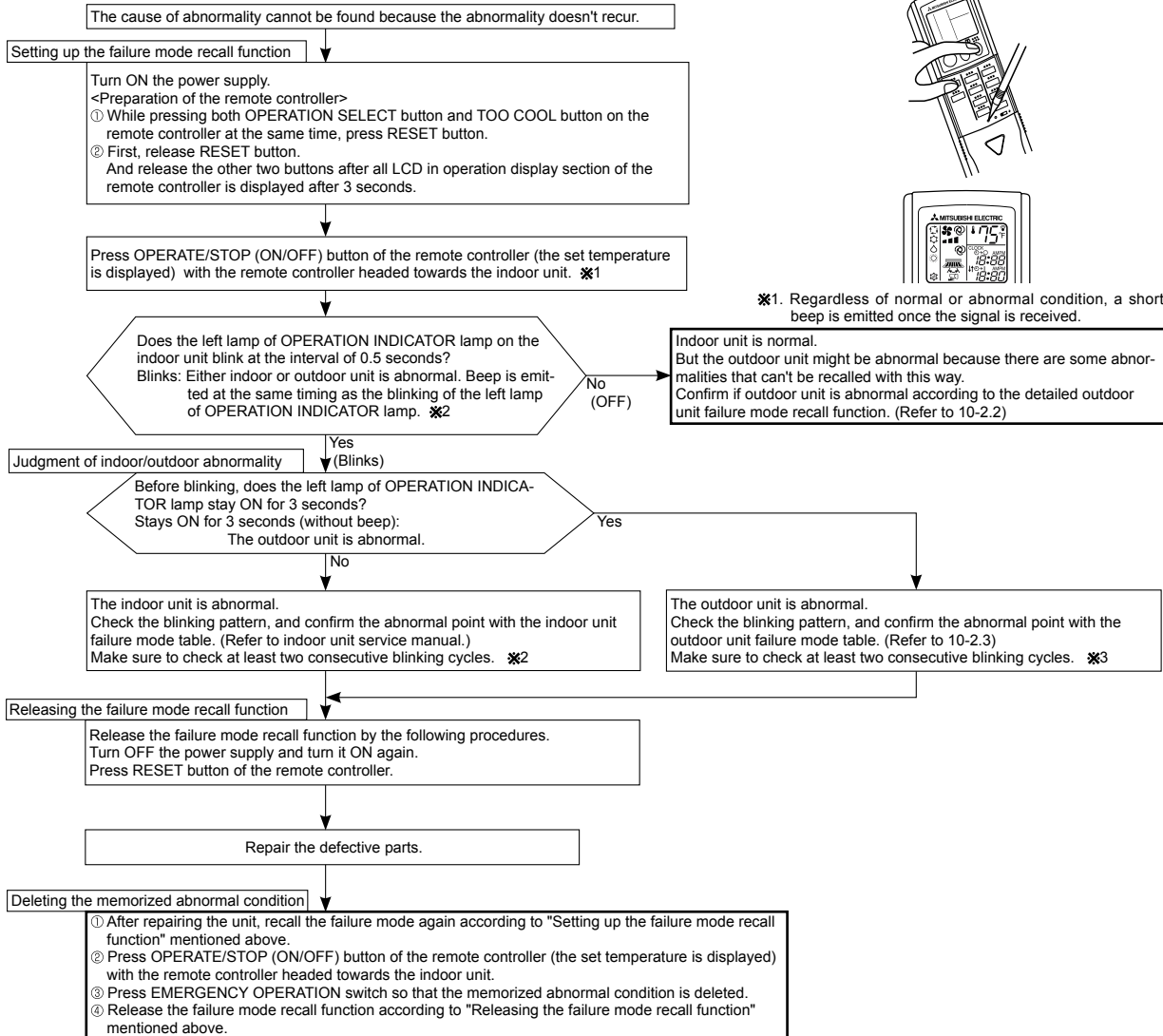

NOTE: 1. Make sure to release the failure mode recall function once it's set up, otherwise the unit cannot operate properly.
2. If the abnormal condition is not deleted from the memory, the last abnormal condition is kept memorized.

※2. Blinking pattern when the indoor unit is abnormal:

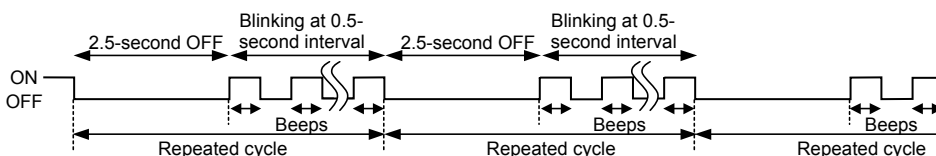

※3. Blinking pattern when the outdoor unit is abnormal:

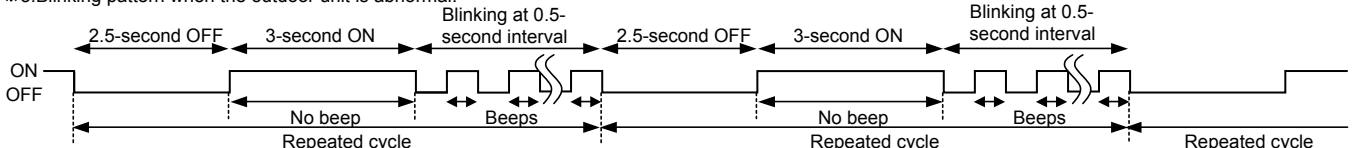

2. Flow chart of the detailed outdoor unit failure mode recall function

Operational procedure

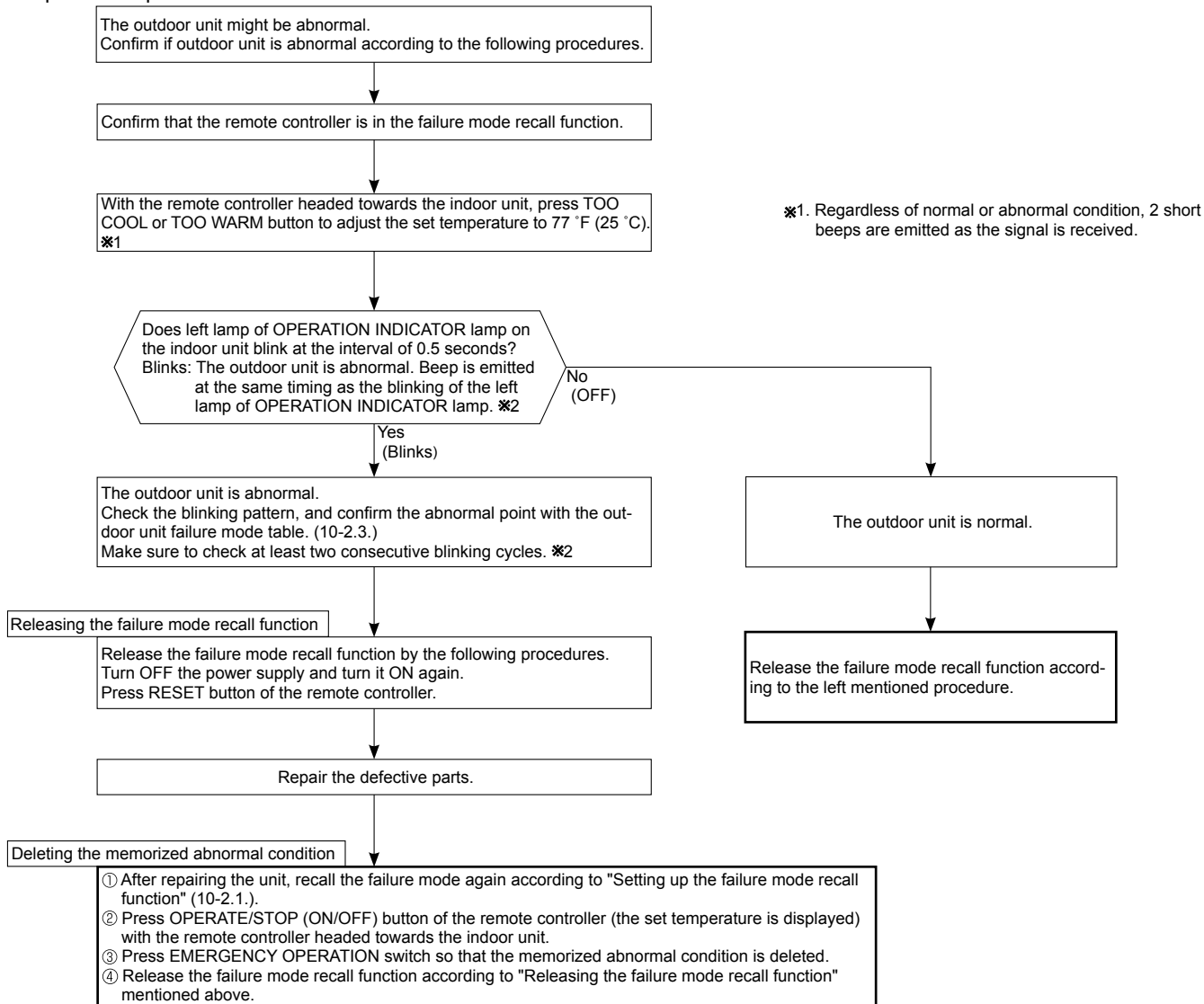

NOTE: 1. Make sure to release the failure mode recall function once it's set up, otherwise the unit cannot operate properly.
2. If the abnormal condition is not deleted from the memory, the last abnormal condition is kept memorized.

*2. Blinking pattern when outdoor unit is abnormal:

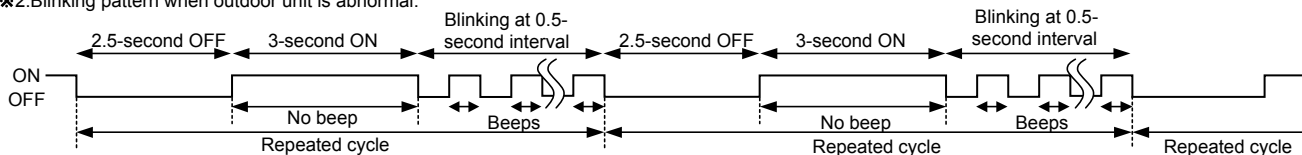

3. Outdoor unit failure mode table

MUZ-D30NA MUZ-D36NA MUY-D30NA MUY-D36NA

The left lamp of OPERATION INDICATOR lamp (Indoor unit)	Abnormal point (Failure mode / protection)	LED indication (Outdoor P.C. board)		Condition	Correspondence	Indoor/outdoor unit failure mode recall function
		LED 1	LED 2			
OFF	Non (Normal)	—	—	—	—	—
2-time flash	Outdoor power system	Lighting	Lighting	IPM protection stop or lock protection stop is continuously performed 3 times within 1 minute after the compressor gets started, or converter protection stop or bus-bar voltage protection stop is continuously performed 3 times within 3 minutes after start-up.	<ul style="list-style-type: none"> • Check the connection of the compressor connecting wire. • Refer to 10-5.④ "How to check inverter / compressor". • Refer to 10-5.⑥ "Check of compressor start failure". • Check the stop valve. 	○
3-time flash	Discharge temperature thermistor	Lighting	Once	Thermistor shorts or opens during compressor running.	<ul style="list-style-type: none"> • Refer to 10-5.⑧ "Check of outdoor thermistors". 	○
	Defrost thermistor (MUZ)	Lighting	Once			
	Ambient temperature thermistor	Lighting	Twice			
	Fin temperature thermistor	Lighting	3 times			
	P.C. board temperature thermistor	Lighting	4 times			
Outdoor heat exchanger temperature thermistor	Lighting	9 times				
4-time flash	Overcurrent	Once	Goes out	28 A current flow into intelligent power module.	<ul style="list-style-type: none"> • Reconnect compressor connector. • Refer to 10-5.④ "How to check inverter/ compressor." • Refer to 10-5.⑥ "Check of compressor start failure". • Check the stop valve. 	—
5-time flash	Discharge temperature	Lighting	Lighting	Temperature of discharge temperature thermistor exceeds 241 °F (116 °C), compressor stops. Compressor can restart if discharge temperature thermistor reads 212 °F (100 °C) or less 3 minutes later.	<ul style="list-style-type: none"> • Check refrigerant circuit and refrigerant amount. • Refer to 10-5.⑩ "Check of LEV". 	—
6-time flash	High pressure	Lighting	Lighting	The outdoor heat exchanger temperature exceeds 158 °F (70 °C) during cooling or the indoor gas pipe temperature exceeds 158 °F (70 °C) during heating (MUZ).	<ul style="list-style-type: none"> • Check refrigerant circuit and refrigerant amount. • Check the stop valve. 	—
7-time flash	Fin temperature	3 times	Goes out	The fin temperature exceeds 189 °F (87 °C) during operation.	<ul style="list-style-type: none"> • Check around outdoor unit. • Check outdoor unit air passage. • Refer to 10-5.⑩ "Check of outdoor fan motor". 	—
	P.C. board temperature	4 times	Goes out	The P.C. board temperature exceeds 158 °F (70 °C) during operation.		
8-time flash	Outdoor fan motor	Lighting	Lighting	Failure occurs continuously 3 times within 30 seconds after the fan gets started.	<ul style="list-style-type: none"> • Refer to 10-5.⑩ "Check of outdoor fan motor". 	—
9-time flash	Nonvolatile memory data	Lighting	5 times	Nonvolatile memory data cannot be read properly.	<ul style="list-style-type: none"> • Replace the outdoor electronic control P.C. board. 	○
10-time flash	Discharge temperature	Lighting	Lighting	The frequency of the compressor is kept 80 Hz or more and the discharge temperature is kept under 102 °F (39 °C) for more than 20 minutes.	<ul style="list-style-type: none"> • Check refrigerant circuit and refrigerant amount. • Refer to 10-5.⑩ "Check of LEV". 	—
11-time flash	Communication error between P.C. boards	Lighting	6 times	Communication error occurs between the electronic control P.C. board and power board for more than 10 seconds.	<ul style="list-style-type: none"> • Check the connecting wire between outdoor electronic control P.C. board and power board. 	—
				The communication between boards protection stop is continuously performed twice.		○
	Current sensor	Lighting	7 times	A short or open circuit is detected in the current sensor during compressor operating.	<ul style="list-style-type: none"> • Replace the power board. 	—
				Current sensor protection stop is continuously performed twice.		○
Zero cross detecting circuit	5 times	Goes out	Zero cross signal cannot be detected while the compressor is operating.	<ul style="list-style-type: none"> • Check the connecting wire among electronic control P.C. board, noise filter P.C. board and power board. 	—	
			The protection stop of the zero cross detecting circuit is continuously performed 10 times.		○	

NOTE : Blinking patterns of this mode differ from the ones of Troubleshooting check table (10-3.).



The left lamp of OPERATION INDICATOR lamp (Indoor unit)	Abnormal point (Failure mode / protection)	LED indication (Outdoor P.C. board)		Condition	Correspondence	Indoor/outdoor unit failure mode recall function
		LED 1	LED 2			
11-time flash	Converter	5 times	Goes out	A failure is detected in the operation of the converter during operation.	*Replace the power board.	—
	Bus-bar voltage (1)	5 times	Goes out	The bus-bar voltage exceeds 400 V or falls to 200 V or below during compressor operating.		
	Bus-bar voltage (2) ※ Even if this protection stop is performed continuously 3 times, it does not mean the abnormality in outdoor power system.	6 times	Goes out	The bus-bar voltage exceeds 400 V or falls to 50 V or below during compressor operating.		

10-3. TROUBLESHOOTING CHECK TABLE

MUZ-D30NA MUZ-D36NA MUY-D30NA MUY-D36NA

No.	Symptom	Indication		Abnormal point / Condition	Condition	Correspondence
		LED1 (Red)	LED2 (Yellow)			
1	Outdoor unit does not operate.	Lightning	Twice	Outdoor power system	IPM protection stop or lock protection stop is continuously performed three times within 1 minute after the compressor gets started, or converter protection stop or bus-bar voltage protection stop is continuously performed 3 times within 3 minutes after start-up.	<ul style="list-style-type: none"> •Check the connection of the compressor connecting wire. •Refer to 10-5.Ⓐ "How to check inverter/compressor". •Refer to 10-5.Ⓒ "Check of compressor start failure". •Check the stop valve.
2		Lightning	3 times	Discharge temperature thermistor	A short circuit is detected in the thermistor during operation, or an open circuit is detected in the thermistor after 10 minutes of compressor start-up.	<ul style="list-style-type: none"> •Refer to 10-5.Ⓒ "Check of outdoor thermistor".
3		Lightning	4 times	Fin temperature thermistor P.C. board temperature thermistor	A short or open circuit is detected in the thermistor during operation.	<ul style="list-style-type: none"> •Refer to 10-5.Ⓒ "Check of outdoor thermistor". •Replace the outdoor electronic control P.C. board.
4		Lightning	5 times	Ambient temperature thermistor Outdoor heat exchanger temperature thermistor Defrost thermistor (MUZ)	A short or open circuit is detected in the thermistor during operation. A short circuit is detected in the thermistor during operation, or an open circuit is detected in the thermistor after 5 minutes (in cooling) and 10 minutes (in heating (MUZ)) of compressor start-up. A short circuit is detected in the thermistor during operation, or an open circuit is detected in the thermistor after 5 minutes of compressor start-up.	<ul style="list-style-type: none"> •Refer to 10-5.Ⓒ "Check of outdoor thermistor".
5		Lightning	6 times	Serial signal	The communication fails between the indoor and outdoor unit for 3 minutes.	<ul style="list-style-type: none"> •Refer to 10-5.Ⓓ "How to check miswiring and serial signal error".
6		Lightning	7 times	Nonvolatile memory data	The nonvolatile memory data cannot be read properly.	<ul style="list-style-type: none"> •Replace the outdoor electronic control P.C. board.
7		Lightning	8 times	Current sensor	Current sensor protection stop is continuously performed twice.	<ul style="list-style-type: none"> •Replace the power board.
8		Lightning	11 times	Communication error between P.C. boards	The communication protection stop between boards is continuously performed twice.	<ul style="list-style-type: none"> •Check the connecting wire between outdoor electronic control P.C. board and power board.
9		Lightning	12 times	Zero cross detecting circuit	The protection stop of the zero cross detecting circuit is continuously performed 10 times.	<ul style="list-style-type: none"> •Check the connecting wire among outdoor electronic control P.C. board, noise filter P.C. board and power board.
10	'Outdoor unit stops and restarts 3 minutes later' is repeated.	Twice	Goes out	IPM protection Lock protection	Overcurrent is detected after 30 minutes of compressor start-up. Overcurrent is detected within 30 minutes of compressor start-up	<ul style="list-style-type: none"> •Reconnect compressor connector. •Refer to 10-5.Ⓐ "How to check inverter/compressor". •Refer to 10-5.Ⓒ "Check of compressor start failure". •Check the stop valve. •Check the power module (PAM module).
11		3 times	Goes out	Discharge temperature protection	Temperature of discharge temperature thermistor exceeds 241 °F (116 °C), compressor stops. Compressor can restart if discharge temperature thermistor reads 212 °F (100 °C) or less 3 minutes later.	<ul style="list-style-type: none"> •Check the amount of gas and refrigerant circuit. •Refer to 10-5.Ⓒ "Check of LEV".
12		4 times	Goes out	Fin temperature protection P.C. board temperature protection	The fin temperature exceeds 189 °F (87 °C) during operation. The P.C. board temperature exceeds 158 °F (70 °C) during operation.	<ul style="list-style-type: none"> •Check refrigerant circuit and refrigerant amount. •Refer to 10-5.Ⓒ "Check of LEV".
13		5 times	Goes out	High-pressure protection	The outdoor heat exchanger temperature exceeds 158 °F (70 °C) during cooling or indoor gas pipe temperature exceeds 158 °F (70 °C) during heating (MUZ).	<ul style="list-style-type: none"> •Check around of gas and the refrigerant circuit. •Check of stop valve.
14		8 times	Goes out	Converter protection	A failure is detected in the operation of the converter during operation.	<ul style="list-style-type: none"> •Replace the power board.
15		9 times	Goes out	Bus-bar voltage protection (1) Bus-bar voltage protection (2)	The bus-bar voltage exceeds 400 V or falls to 200 V or below during compressor operating. The bus-bar voltage exceeds 400 V or falls to 50 V or below during compressor operating.	<ul style="list-style-type: none"> •Replace the power board.
16		13 times	Goes out	Outdoor fan motor	Failure occurs continuously three times within 30 seconds after the fan gets started.	<ul style="list-style-type: none"> •Refer to 10-5.Ⓒ "Check of outdoor fan motor".
17		Lighting	8 times	Current sensor protection	A short or open circuit is detected in the current sensor during compressor operating.	<ul style="list-style-type: none"> •Replace the power board.
18		Lighting	11 times	Communication between P.C. boards protection	Communication error occurs between the outdoor electronic control P.C. board and power board for more than 10 seconds.	<ul style="list-style-type: none"> •Check the connecting wire between outdoor electronic control P.C. board and power board.
19	Lighting	12 times	Zero cross detecting circuit protection	Zero cross signal cannot be detected while the compressor is operating.	<ul style="list-style-type: none"> •Check the connecting wire among outdoor electronic control P.C. board, noise filter P.C. board and power board. 	

NOTE 1. The location of LED is illustrated at the right figure. Refer to 10-6.1.
2. LED is lighted during normal operation.

Outdoor electronic control P.C. board(Parts side)

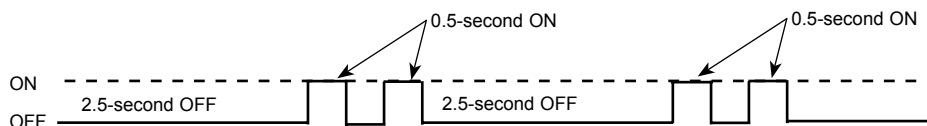
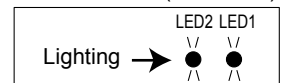

The flashing frequency shows the number of times the LED blinks after every 2.5-second OFF.
(Example) When the flashing frequency is "2".



No.	Symptom	Indication		Abnormal point / Condition	Condition	Correspondence
		LED1 (Red)	LED2 (Yellow)			
20	Outdoor unit operates.	Once	Lighting	Primary current protection	The input current exceeds 15 A.	<ul style="list-style-type: none"> • These symptoms do not mean any abnormality of the product, but check the following points. • Check if indoor filters are clogged. • Check if refrigerant is short. • Check if indoor/outdoor unit air circulation is short cycled.
				Secondary current protection	The current of the compressor exceeds 15 A.	
21		Twice	Lighting	High-pressure protection (MUZ)	The indoor gas pipe temperature exceeds 113 °F (45 °C) during heating.	
				Defrosting in cooling	The indoor gas pipe temperature falls 37 °F (3 °C) or below during cooling.	
22		3 times	Lighting	Discharge temperature protection	The discharge temperature exceeds 212 °F (100 °C) during operation.	
23	4 times	Lighting	Low discharge temperature protection	The frequency of the compressor is kept 80 Hz or more and the discharge temperature is kept under 102 °F (39 °C) for more than 20 minutes.	<ul style="list-style-type: none"> • Refer to 10-5.Ⓒ "Check of LEV". • Check refrigerant circuit and refrigerant amount. 	
24	5 times	Lighting	Cooling high-pressure protection	The outdoor heat exchanger temperature exceeds 136 °F (58 °C) during operation.	<ul style="list-style-type: none"> • This symptom does not mean any abnormality of the product, but check the following points. • Check if indoor filters are clogged. • Check if refrigerant is short. • Check if indoor/outdoor unit air circulation is short cycled. 	
25	Outdoor unit operates	9 times	Lighting	Inverter check mode	The unit is operated with emergency operation switch.	–
26	Outdoor unit operates	Lighting	Lighting	Normal	–	–

10-4. TROUBLE CRITERION OF MAIN PARTS
MUZ-D30NA MUZ-D36NA MUY-D30NA MUY-D36NA

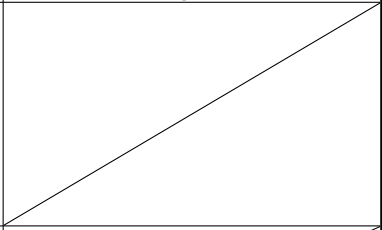
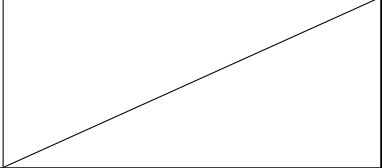
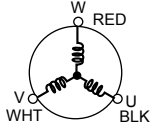
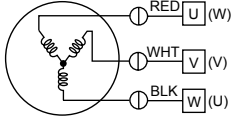
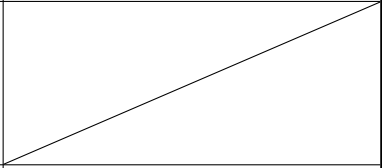
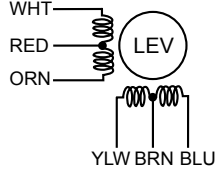
Part name	Check method and criterion	Figure							
Defrost thermistor (RT61) (MUZ) Ambient temperature thermistor (RT65) Outdoor heat exchanger temperature thermistor (RT68)	Measure the resistance with a tester. Refer to 10-6. "Test point diagram and voltage", 1. "Outdoor electronic control P.C. board", the chart of thermistor.								
Discharge temperature thermistor (RT62) Fin temperature thermistor (RT64)	Measure the resistance with a tester. Before measurement, hold the thermistor with your hands to warm it up. Refer to 10-6. "Test point diagram and voltage", 1. "Outdoor electronic control P.C. board", the chart of thermistor.								
Compressor	Measure the resistance between terminals using a tester. (Winding temperature : 14 ~ 104 °F (-10 ~ 40 °C)) <table border="1" data-bbox="416 804 687 889"> <tr> <td style="text-align: center;">Normal</td> </tr> <tr> <td style="text-align: center;">1.24 ~ 1.53 Ω</td> </tr> </table>	Normal	1.24 ~ 1.53 Ω						
Normal									
1.24 ~ 1.53 Ω									
Outdoor fan motor	Measure the resistance between lead wires using a tester. (Part temperature : 14 ~ 104 °F (-10 ~ 40 °C)) <table border="1" data-bbox="408 976 887 1104"> <tr> <td>Color of lead wire</td> <td>Normal</td> </tr> <tr> <td>RED – BLK</td> <td rowspan="3" style="text-align: center;">13 ~ 16 Ω</td> </tr> <tr> <td>BLK – WHT</td> </tr> <tr> <td>WHT – RED</td> </tr> </table>	Color of lead wire	Normal	RED – BLK	13 ~ 16 Ω	BLK – WHT	WHT – RED		
Color of lead wire	Normal								
RED – BLK	13 ~ 16 Ω								
BLK – WHT									
WHT – RED									
R. V. coil (MUZ)	Measure the resistance using a tester. (Part temperature : 14 ~ 104 °F (-10 ~ 40 °C)) <table border="1" data-bbox="416 1189 687 1274"> <tr> <td style="text-align: center;">Normal</td> </tr> <tr> <td style="text-align: center;">1.20 ~ 1.55 kΩ</td> </tr> </table>	Normal	1.20 ~ 1.55 kΩ						
Normal									
1.20 ~ 1.55 kΩ									
Linear expansion valve	Measure the resistance using a tester. (Part temperature : 14 ~ 104 °F (-10 ~ 40 °C)) <table border="1" data-bbox="408 1359 906 1519"> <tr> <td>Color of lead wire</td> <td>Normal</td> </tr> <tr> <td>WHT – RED</td> <td rowspan="4" style="text-align: center;">38 ~ 50 Ω</td> </tr> <tr> <td>RED – ORN</td> </tr> <tr> <td>YLW – BRN</td> </tr> <tr> <td>BRN – BLU</td> </tr> </table>	Color of lead wire	Normal	WHT – RED	38 ~ 50 Ω	RED – ORN	YLW – BRN	BRN – BLU	
Color of lead wire	Normal								
WHT – RED	38 ~ 50 Ω								
RED – ORN									
YLW – BRN									
BRN – BLU									

10-5. TROUBLESHOOTING FLOW

**OPERATION / INDICATOR lamp flashes 5-times.
Outdoor unit does not operate.**

Ⓐ How to check inverter/ compressor

Disconnect the terminal of the compressor. 3 minutes after turning on the power supply, start EMERGENCY OPERATION.

※ •After the outdoor fan starts running, wait for 1 minute or more before measuring the voltage.
•The output voltage values have the tolerance of $\pm 20\%$.

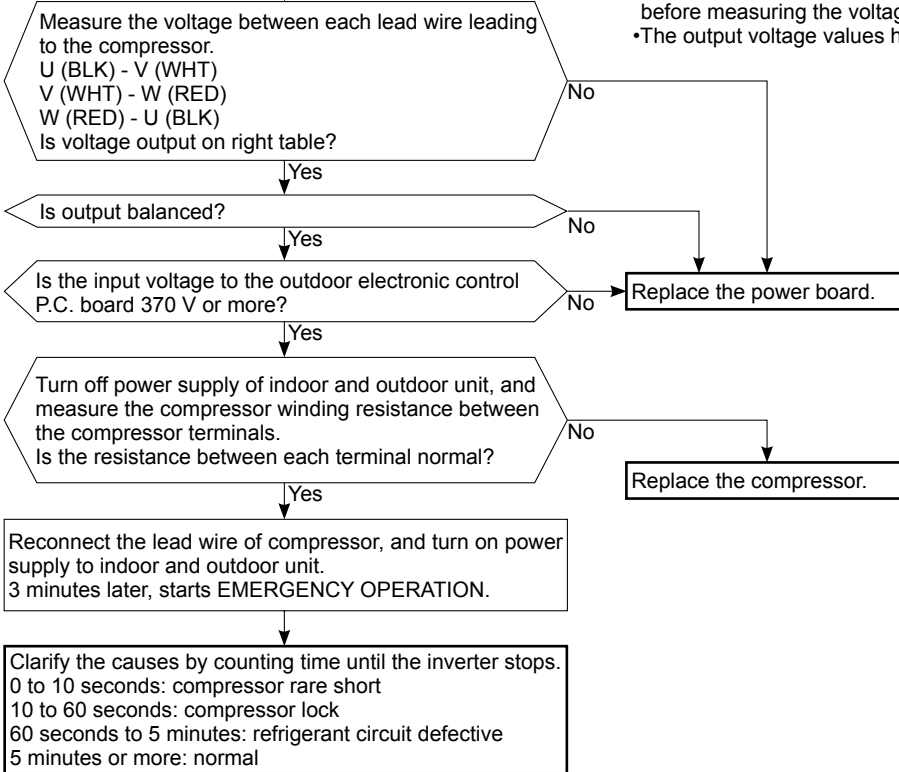

**OPERATION INDICATOR lamp flashes 6-times.
Thermistor is abnormal.**

B Check of outdoor thermistors

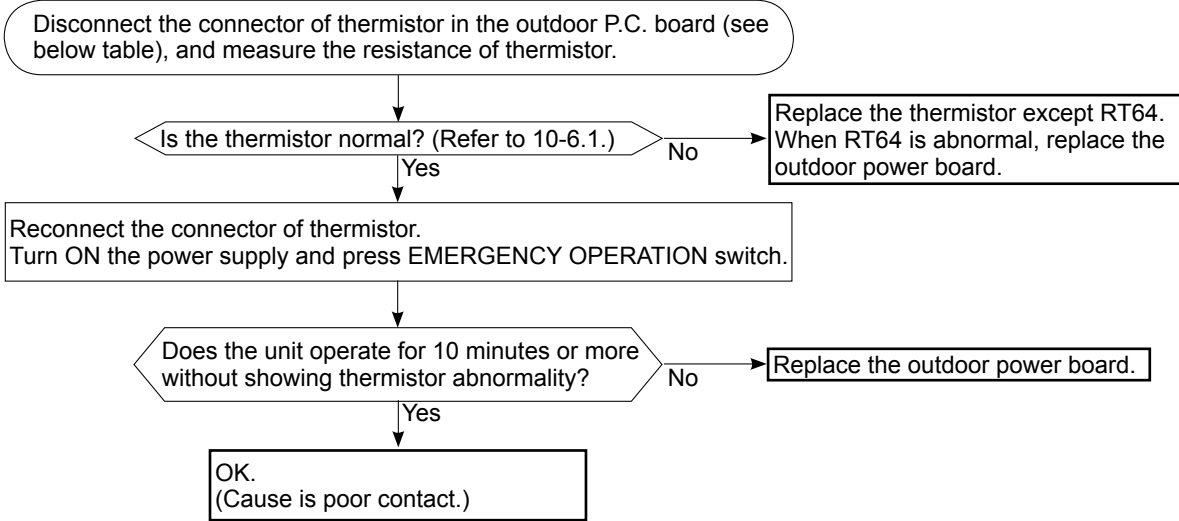

Thermistor	Symbol	Connector, Pin No.	Board
Defrost (MUZ)	RT61	Between CN661 pin1 and pin2	Outdoor electronic control P.C. board
Discharge temperature	RT62	Between CN661 pin3 and pin4	
Outdoor heat exchanger temperature	RT68	Between CN661 pin7 and pin8	
Ambient temperature	RT65	Between CN663 pin1 and pin2	Outdoor power board
Fin temperature	RT64	Between CN3 pin1 and pin2	

The cooling operation or heating operation does not operate.

© Check of R.V. coil

MUZ-D30/36

• Heating operation does not work.

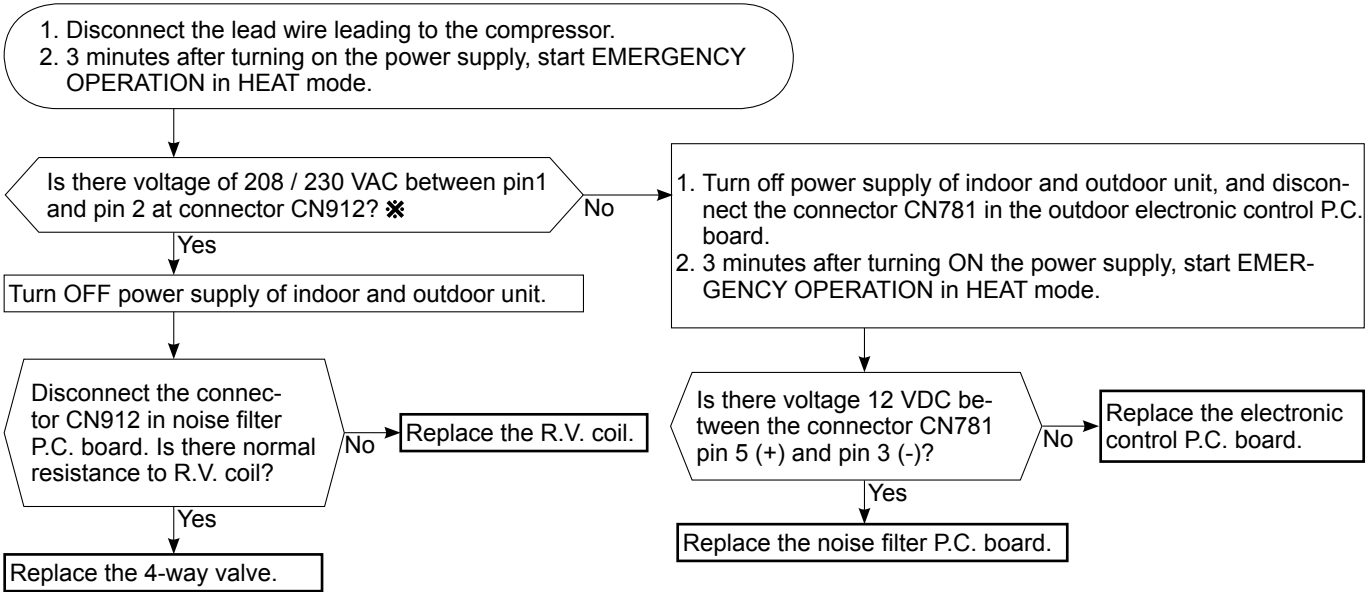

• Cooling operation does not work.

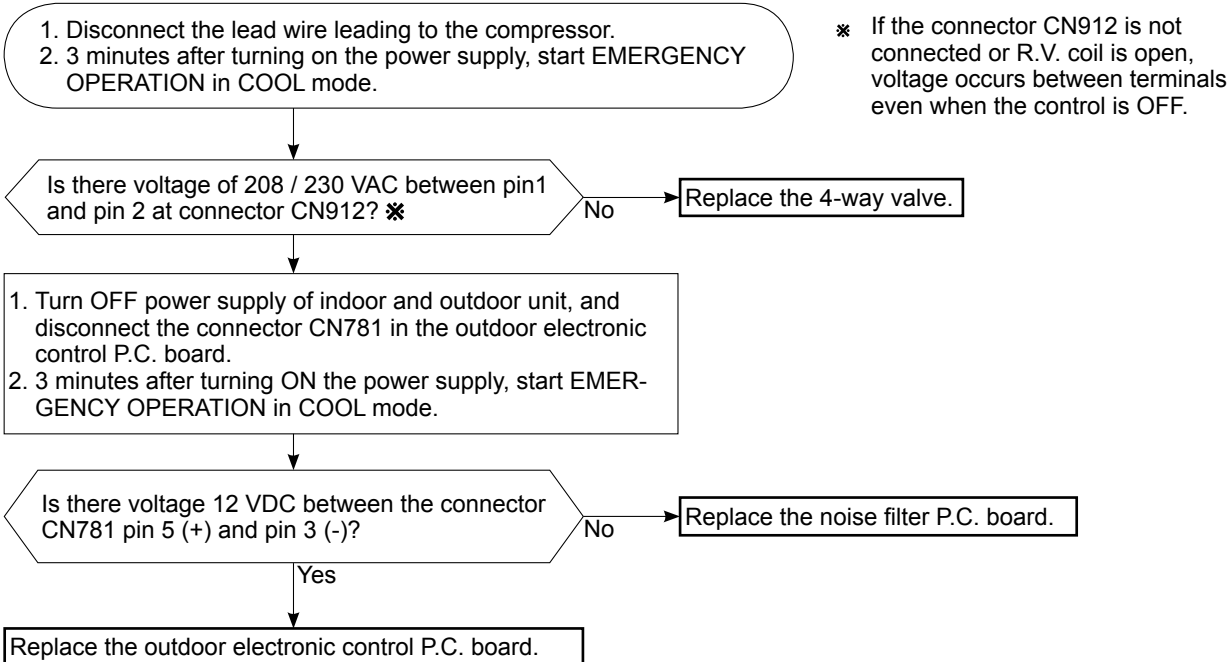

※ If the connector CN912 is not connected or R.V. coil is open, voltage occurs between terminals even when the control is OFF.

Fan motor does not operate or stops operating shortly after starting the operation.

D Check of outdoor fan motor

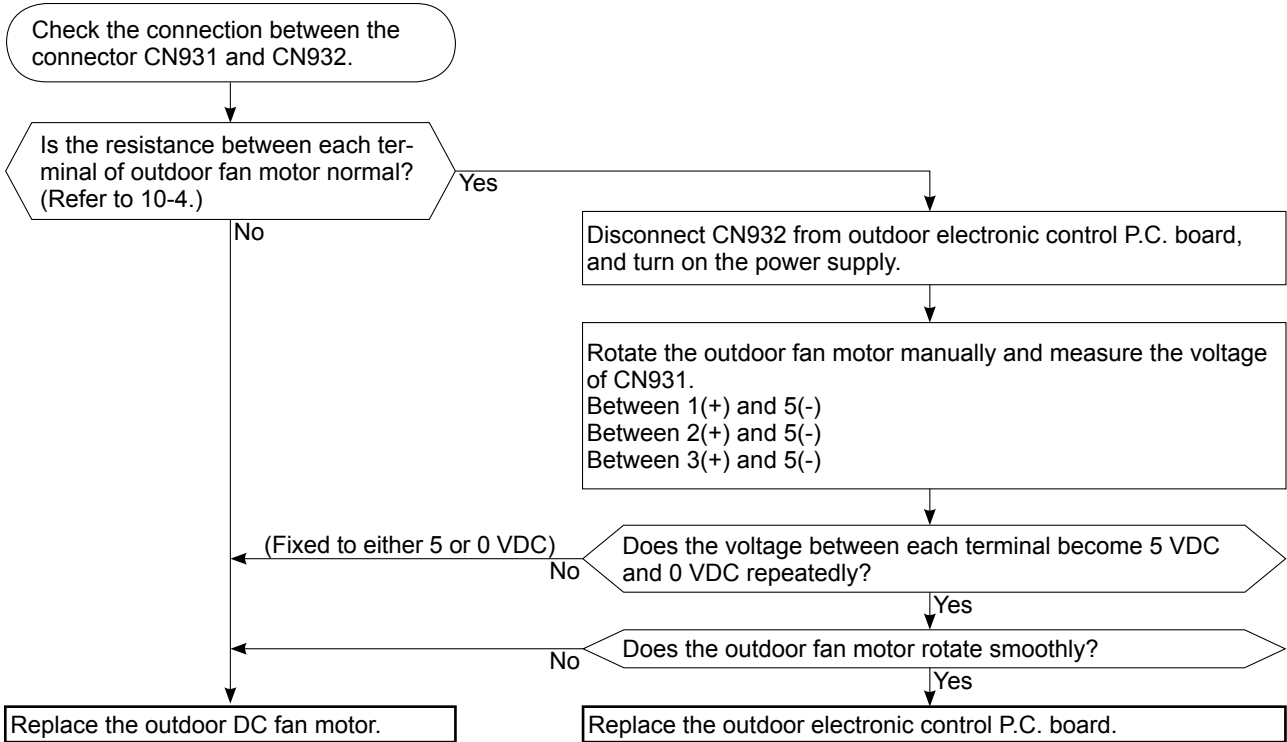

Outdoor unit does not operate.

E Check of power supply

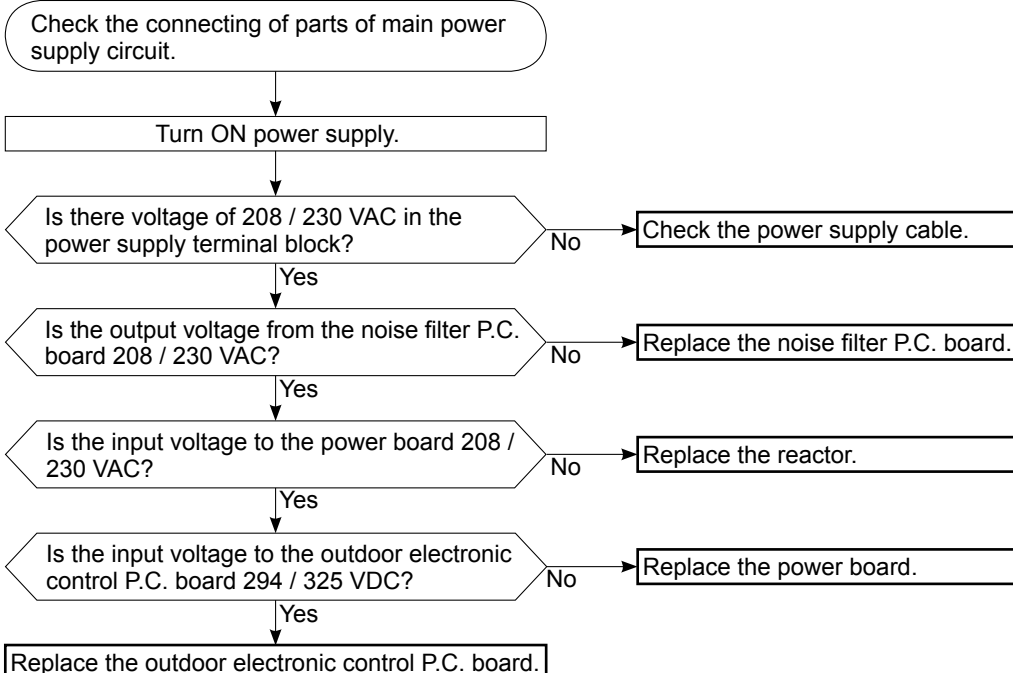

F Check of compressor start failure

Confirm that 1~4 is normal.

•Electrical circuit check

1. Contact of lead wire leading to compressor
2. Output voltage of the outdoor electronic control P.C. board and balance of them (See 10-5.㉔)
3. Direct current voltage to the outdoor electronic control P.C. board
4. Voltage between outdoor terminal block S1-S2

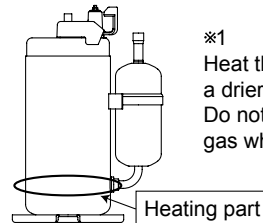
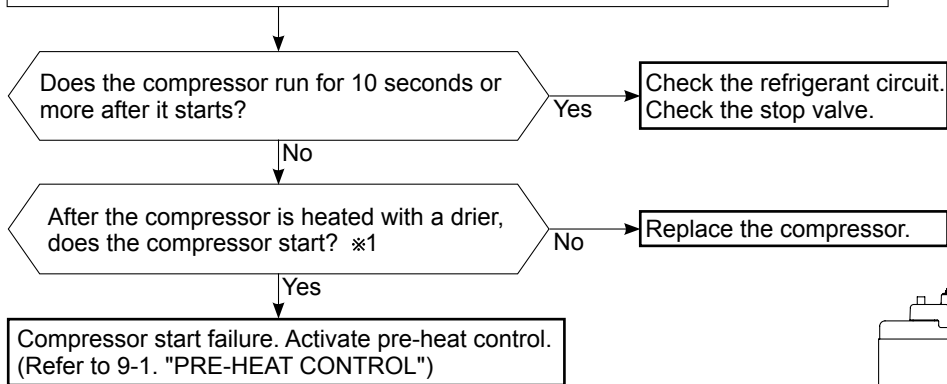

※1
Heat the compressor with a drier for about 20 minutes. Do not recover refrigerant gas while heating.

**When cooling, heat exchanger of non-operating indoor unit frosts.
When heating, non-operating indoor unit gets warm.**

G Check of LEV

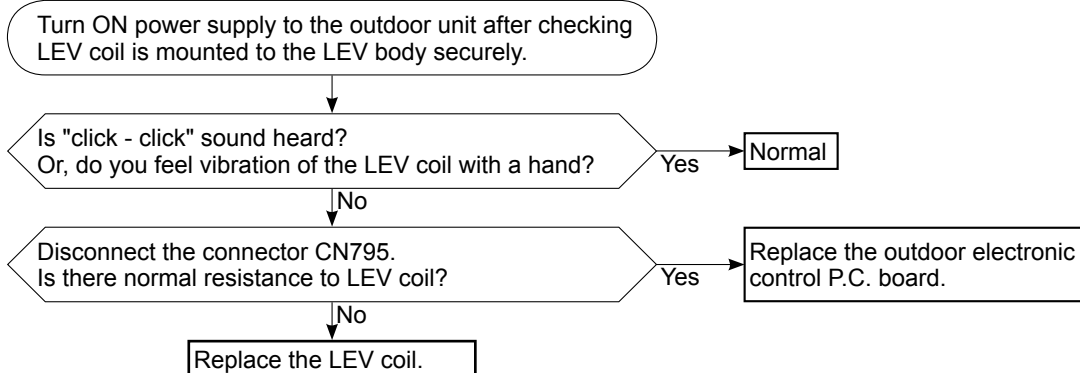

- Unit cannot operate neither by the remote controller nor by EMERGENCY OPERATION switch. Indoor unit does not operate.
- OPERATION INDICATOR lamp flashes ON and OFF in every 0.5 seconds. Outdoor unit doesn't operate.

H How to check miswiring and serial signal error

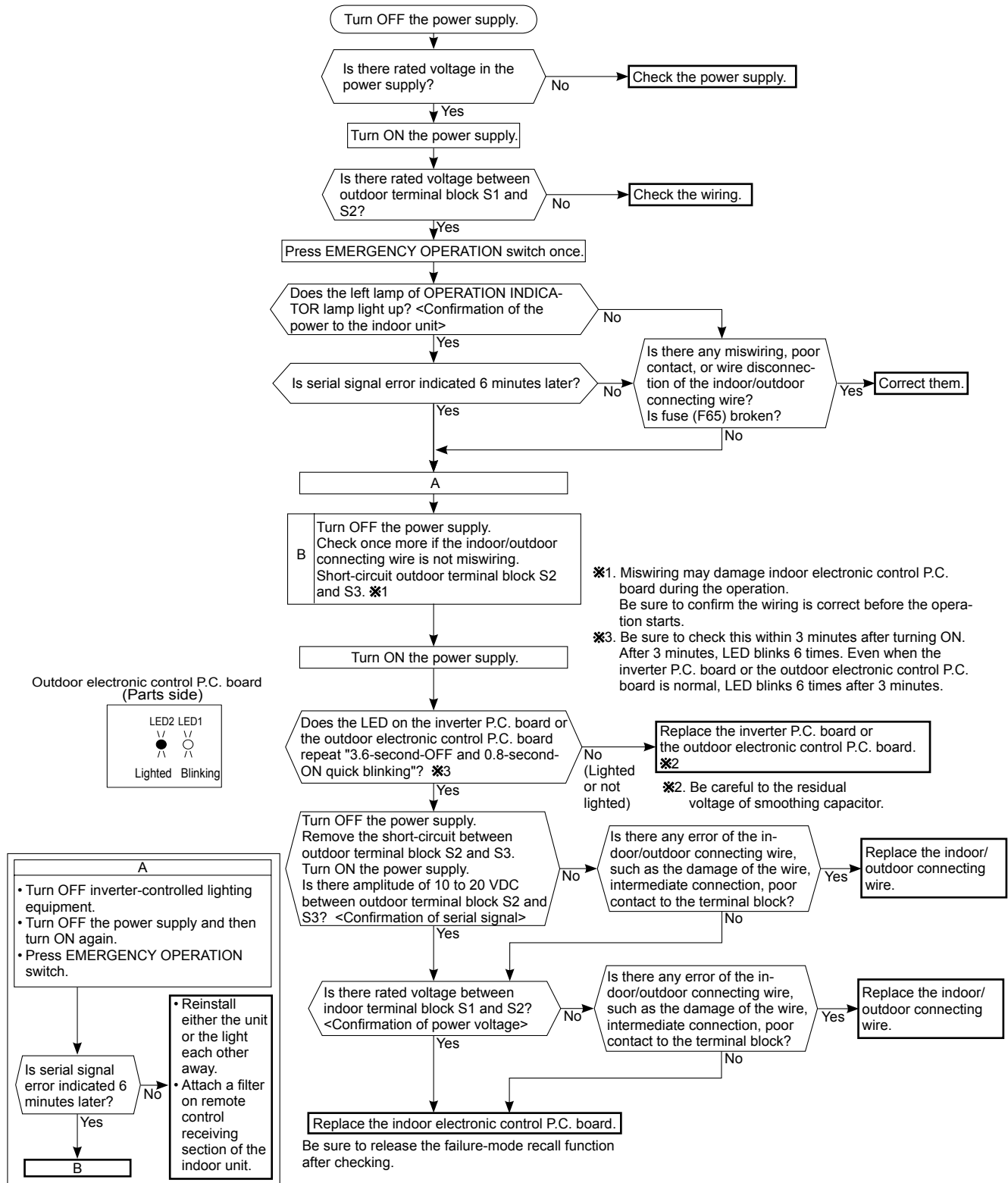

The operation frequency does not go up from lowest frequency.

① Check of HPS

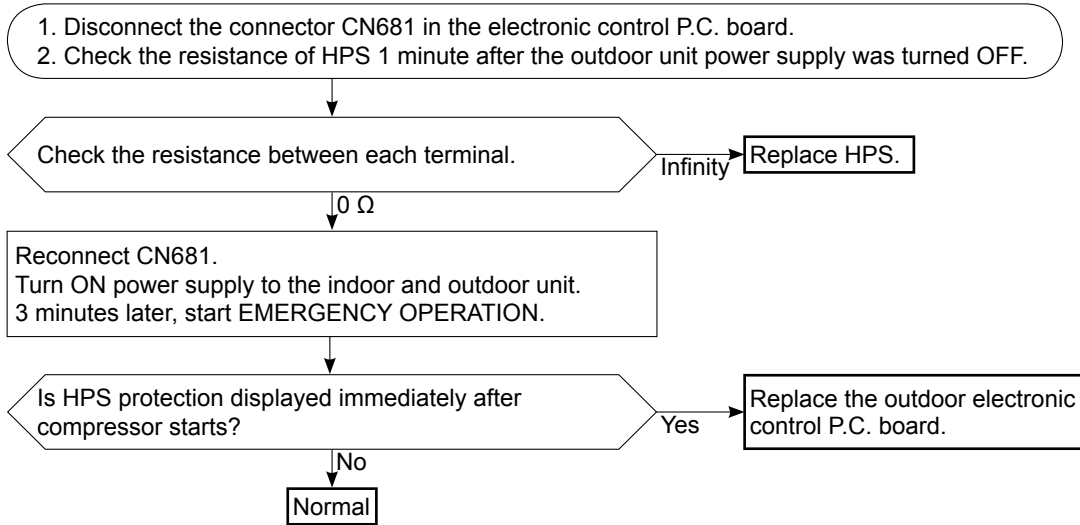

J Electromagnetic noise enters into TV sets or radios

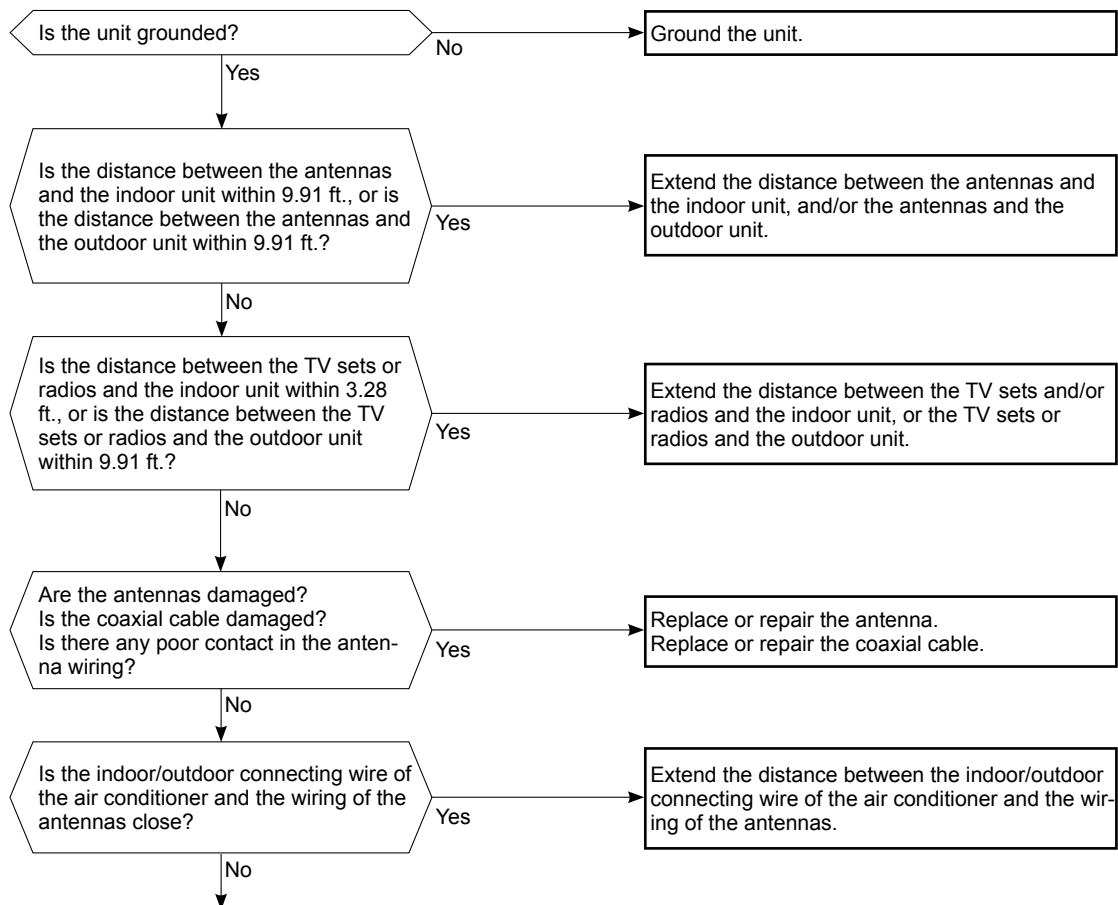

Even if all of the above conditions are fulfilled, the electromagnetic noise may enter, depending on the electric field strength or the installation condition (combination of specific conditions such as antennas or wiring).

Check the followings before asking for service.

1. Devices affected by the electromagnetic noise
TV sets, radios (FM/AM broadcast, shortwave)
2. Channel, frequency, broadcast station affected by the electromagnetic noise
3. Channel, frequency, broadcast station unaffected by the electromagnetic noise
4. Layout of ;
indoor/outdoor unit of the air conditioner, indoor/outdoor wiring, grounding wire, antennas, wiring from antennas, receiver
5. Electric field intensity of the broadcast station affected by the electromagnetic noise
6. Presence or absence of amplifier such as booster
7. Operation condition of air conditioner when the electromagnetic noise enters in
 - 1) Turn OFF the power supply once, and then turn ON the power supply. In this situation, check for the electromagnetic noise.
 - 2) Within 3 minutes after turning ON the power supply, press OPERATE/STOP (ON/OFF) button on the remote controller for power ON, and check for the electromagnetic noise.
 - 3) After a short time (3 minutes later after turning ON), the outdoor unit starts running. During operation, check for the electromagnetic noise.
 - 4) Press OPERATE/STOP (ON/OFF) button on the remote controller for power OFF, when the outdoor unit stops but the indoor/outdoor communication still runs on. In this situation, check for the electromagnetic noise.

10-6. TEST POINT DIAGRAM AND VOLTAGE

1. Outdoor electronic control P.C. board

MUZ-D30NA MUZ-D36NA MUY-D30NA MUY-D36NA

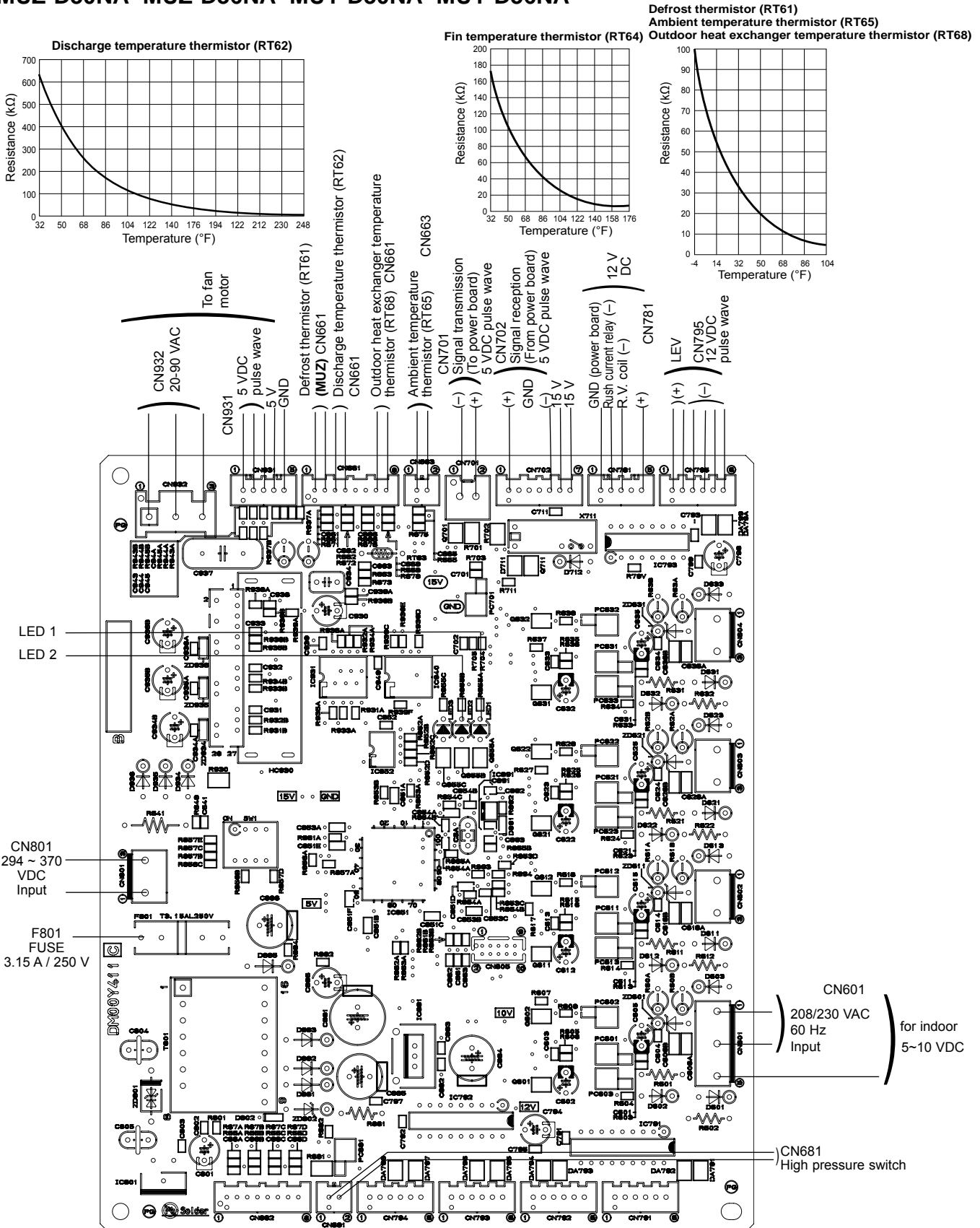

2. Noise filter P.C. board

MUZ-D30NA MUZ-D36NA MUY-D30NA MUY-D36NA

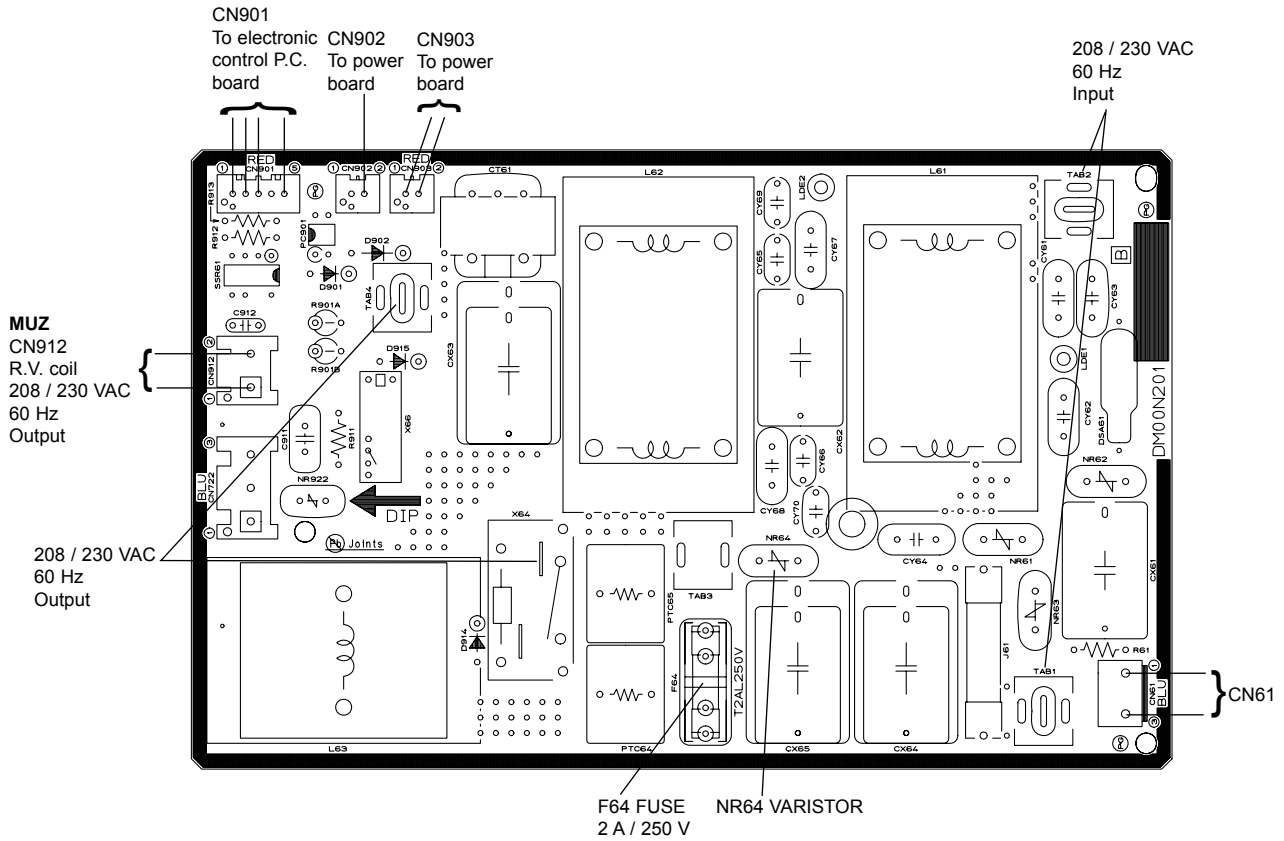

3. Outdoor power board

MUZ-D30NA MUZ-D36NA MUY-D30NA MUY-D36NA

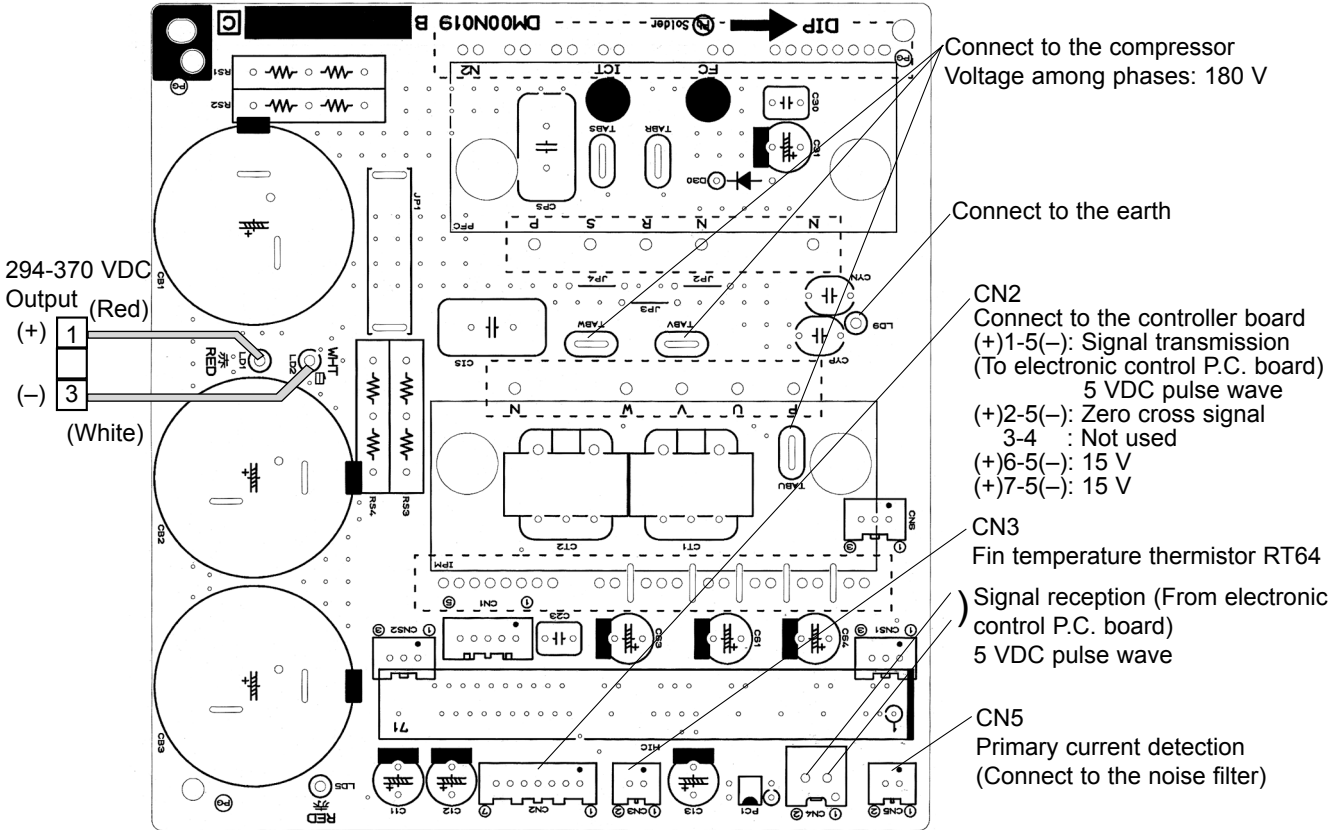

<"Terminal with locking mechanism" Detaching points>

The terminal which has the locking mechanism can be detached as shown below.
 There are two types (Refer to (1) and (2)) of the terminal with locking mechanism.
 The terminal without locking mechanism can be detached by pulling it out.
 Check the shape of the terminal before detaching.

(1) Slide the sleeve and check if there is a locking lever or not.

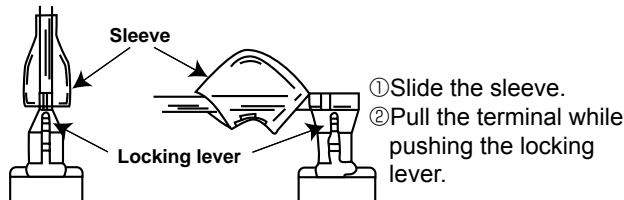

(2) The terminal with this connector has the locking mechanism.

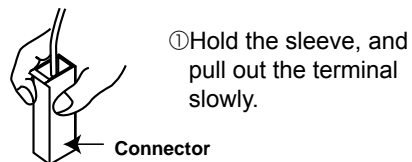

MUZ-D30NA MUZ-D36NA MUY-D30NA MUY-D36NA

OPERATING PROCEDURE	PHOTOS
<p>1. Removing the cabinet</p> <ol style="list-style-type: none"> (1) Remove the screws of the service panel. (2) Remove the screws of the top panel. (3) Remove the screw of the valve cover. (4) Remove the service panel. (5) Remove the top panel. (6) Remove the valve cover. (7) Remove the screws of the cabinet. (8) Remove the cabinet. (9) Remove the screws of the back panel. (10) Remove the back panel. <p>Photo 3</p> <p>Screw of the motor support</p> <p>Conduit plate</p> <p>Screws of the back panel</p> <p>Set screws of the back panel</p>	<p>Photo 1</p> <p>Screw of the top panel</p> <p>Screws of the cabinet</p> <p>Screws of the cabinet</p> <p>Photo 2</p> <p>Screw of the service panel</p> <p>Screws of the top panel</p> <p>Set screws of the back panel</p> <p>Screws of the cabinet</p> <p>Screw of the valve cover</p>

OPERATING PROCEDURE

2. Removing the inverter assembly, P.C. board and power board

- (1) Remove the top panel, cabinet, service panel and the back panel. (Refer to 1.)
- (2) Disconnect the following connectors;
<Electronic control P.C. board>
CN931 and CN932 (Fan motor)
CN795 (LEV)
CN661 (Discharge temperature thermistor, defrost thermistor (MUZ) and outdoor heat exchanger temperature thermistor)
CN663 (Ambient temperature thermistor)
CN681 (High pressure switch) (MUZ)
<Noise filter P.C. board>
CN912 (4-way valve) (MUZ)
<Compressor>
<Reactor>
- (4) Remove the screws fixing the relay panel.
- (5) Remove the inverter assembly.
- (6) Disconnect all connectors and lead wires on the electronic control P.C. board.
- (7) Remove the electronic control P.C. board from the inverter assembly.
- (8) Remove the screws fixing the power board assembly.
- (9) Disconnect all connectors and lead wires on the power board.
- (10) Remove the power board from the inverter assembly.
- (11) Disconnect all connectors and lead wires on the noise filter P.C. board.
- (12) Remove the noise filter P.C. board from the inverter assembly.

3. Removing R.V. coil (MUZ)

- (1) Remove the top panel, cabinet, service panel and the back panel. (Refer to 1.)
- (2) Disconnect the following connectors;
<Noise filter P.C. board>
CN912 (4-way valve)
- (3) Remove the R.V. coil. (Photo 9)

PHOTOS

Photo 4

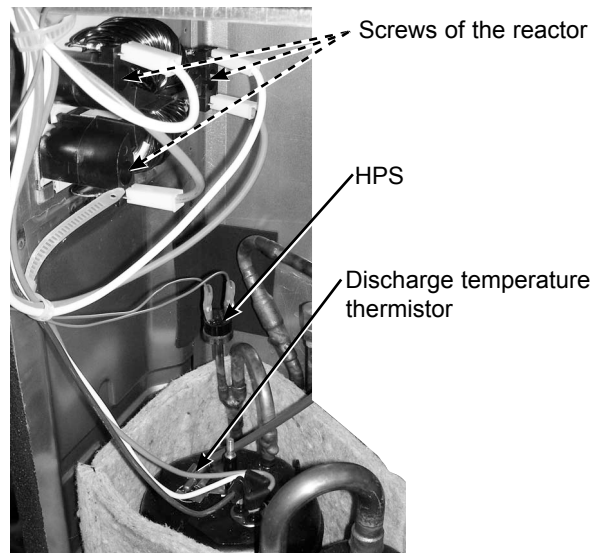

Photo 5 (Inverter assembly)

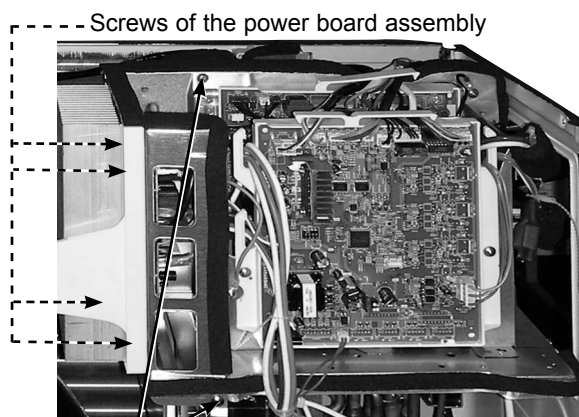
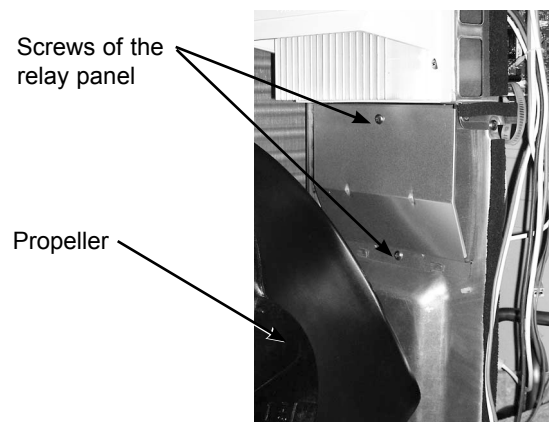

Photo 6



OPERATING PROCEDURE

4. Removing the defrost thermistor (MUZ), discharge temperature thermistor, outdoor heat exchanger temperature thermistor and ambient temperature thermistor

- (1) Remove the top panel, cabinet, service panel and the back panel. (Refer to 1.)
- (2) Disconnect the following connectors;
<Electronic control P.C. board>
CN661 (Discharge temperature thermistor, defrost thermistor (MUZ) and outdoor heat exchanger temperature thermistor)
CN663 (Ambient temperature thermistor)
- (3) Pull out the defrost thermistor from its holder. (Photo 7) (MUZ)
- (4) Pull out the discharge temperature thermistor from its holder. (Photo 4)
- (5) Pull out the outdoor heat exchanger temperature thermistor from its holder. (Photo 7)
- (6) Pull out the ambient temperature thermistor from its holder. (Photo 7)

PHOTOS

Photo 7

Outdoor heat exchanger temperature thermistor

Ambient temperature thermistor

Defrost thermistor (for MUZ)

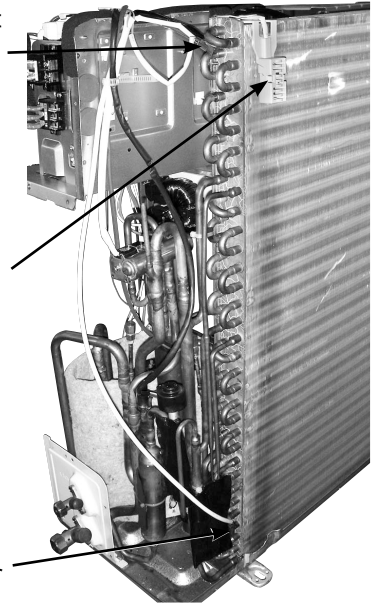

5. Removing outdoor fan motor

- (1) Remove the top panel, cabinet, service panel and the back panel. (Refer to 1.)
- (2) Disconnect the following connectors;
<Electronic control P.C. board>
CN931 and CN932 (Fan motor)
- (3) Remove the propeller.
- (4) Remove the screws fixing the outdoor fan motor.
- (5) Remove the outdoor fan motor.

Photo 8

Screws of the outdoor fan motor

Propeller

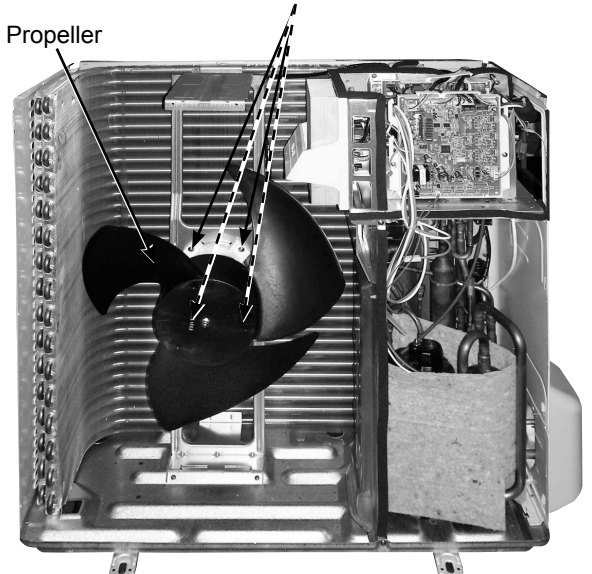

OPERATING PROCEDURE

6. Removing the compressor and 4-way valve

- (1) Remove the top panel, cabinet, service panel and the back panel. (Refer to 1.)
- (2) Remove the inverter assembly. (Refer to 2.)
- (3) Remove the R.V. coil. (Refer to 3.)
- (4) Recover gas from the refrigerant circuit.

NOTE: Recover gas from the pipes until the pressure gauge shows 0 PSIG.

- (5) Detach the welded part of the suction and the discharge pipe connected with compressor. (Photo 9)
- (6) Remove the compressor nuts.
- (7) Remove the compressor.
- (8) Detach the welded part of 4-way valve and pipe. (Photo 8)

PHOTOS

Photo 9

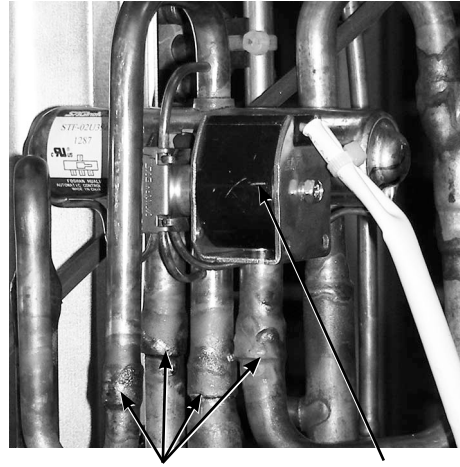

Welded parts of 4-way valve R.V. coil

Photo 10

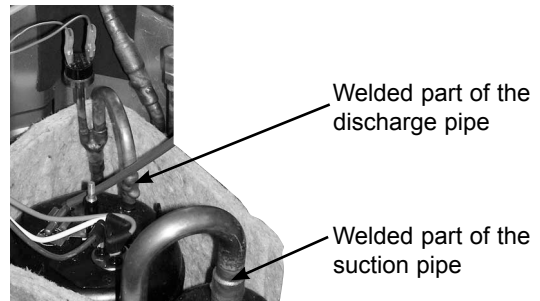

Welded part of the
discharge pipe

Welded part of the
suction pipe

7. Removing the reactor

- (1) Remove the top panel, cabinet, service panel and the back panel. (Refer to 1.)
- (2) Disconnect the reactor lead wire.
- (3) Remove the screws of the reactor, and remove the reactor.

Mr. SLIM™

 **MITSUBISHI ELECTRIC CORPORATION**
HEAD OFFICE: TOKYO BLDG., 2-7-3, MARUNOUCHI, CHIYODA-KU, TOKYO 100-8310, JAPAN

© Copyright 2008 MITSUBISHI ELECTRIC ENGINEERING CO.,LTD
Distributed in Feb. 2008. No. OBH502 7
Made in Japan

New publication, effective Feb. 2008
Specifications subject to change without notice.